

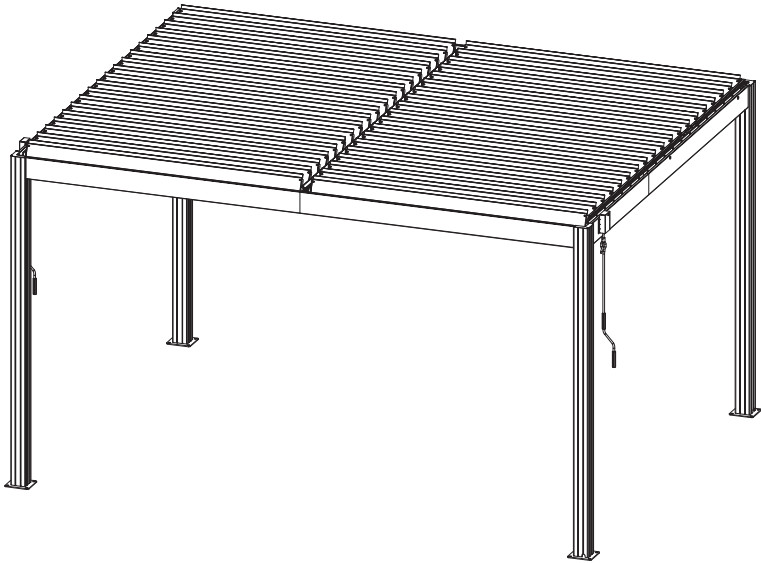

# Manual

## Louvered Outdoor Pergola G21

### Austin 4x3 m



EN DE CZ SK HU PL HR SLO

۲۱

**EN**

## **Thank you for purchasing our product.**

Before using this unit, please read this manual.

### **Assembly instructions:**

Prior to the assembly please read all instructions and information carefully. Check whether you have all parts which are necessary for the assembly.

### **Please mind your own safety.**

1. Use protective clothing and gloves as some parts might be sharp.
2. During the assembly no children or pets should be present in the working area.

### **Care and maintenance:**

Clean with a rag and water.

The English version of the manual is an exact translation of the original manufacturer's instructions. Images used in this manual are for illustrational purposes only and may differ from the actual product.

**DE**

## **Vielen Dank für den Kauf unseres Produktes.**

Bevor Sie dieses Gerät verwenden, lesen Sie diese Anleitung.

### **Montageanleitung:**

Vor der Montage lesen Sie bitte alle Anweisungen und Angaben vorsichtig. Überprüfen Sie, ob alle Teile, die für die Montage notwendig sind, vorhanden sind.

### **Bitte beachten Sie zu Ihrer eigenen Sicherheit.**

1. Tragen Sie Schutzkleidung und Arbeitshandschuhe, da einige Teile scharfe Kanten haben können.
2. Während des Zusammenbaus sollten sich keine Kinder oder Tiere im Arbeitsbereich aufhalten.

### **Pflege und Wartung:**

Mit einem Lappen und Wasser reinigen.

Die deutsche Version der Anleitung ist eine genaue Übersetzung der Anleitung des Herstellers. Die in diesem Handbuch verwendeten Bilder dienen nur zur Illustration und können nicht genau das Produkt entsprechen.

**GZ**

## **Děkujeme za nákup našeho výrobku.**

Před použitím si prosím přečtete tento návod.

### **Montážní návod:**

Dříve, než začnete s montáží, pečlivě si prostudujte všechny pokyny a informace. Zkontrolujte, zda máte všechny potřebné díly pro stavbu.

### **Dbejte na svoji bezpečnost.**

1. Při montáži použijte ochranný oděv a rukavice, protože některé části mohou být ostré.
2. V době montáže by se po staveništi neměly pohybovat děti a domácí zvířata.

### **Péče a údržba:**

Čistěte za pomoci hadru a vody.

Česká verze návodu je přesným překladem originálního návodu výrobce.

Fotografie použité v manuálu jsou pouze ilustrační a nemusí se přesně shodovat s výrobkem.

**SK**

## **Ďakujeme za nákup nášho výrobku.**

Pred použitím si prosím prečítajte tento návod.

### **Montážny návod:**

Skôr, než začnete s montážou, pozorne si preštudujte všetky pokyny a informácie. Skontrolujte, či máte všetky potrebné diely na stavbu.

### **Dbajte na svoju bezpečnosť.**

1. Pri montáži používajte ochranný odev a rukavice, pretože niektoré časti môžu byť ostré.
2. V čase montáže by sa po stavenisku nemali pohybovať deti a domáce zvieratá.

### **Starostlivosť a údržba:**

Čistíte za pomocou handry a vody.

Slovenská verzia návodu je presným prekladom originálneho návodu výrobcu.

Fotografie použité v návode sú len ilustračné a nemusia sa presne zhodovať s výrobkom.



## **Köszönjük, hogy megvásárolta termékünket.**

Kérjük, használat előtt olvassa el ezt a kézikönyvet.

### **Telepítési útmutató:**

Kérjük, az összeszerelés megkezdése előtt figyelmesen olvassa el az összes utasítást és információt. Győződjön meg arról, hogy minden alkatrész megvan, amelyre szüksége van az építéshez.

### **Ügyeljen a biztonságára.**

1. Összeszereléskor viseljen védőruházatot és védőkesztyűt, mivel egyes részek élesek lehetnek.
2. Gyerekek és háziállatok nem tartózkodhatnak az építkezésen az összeszerelés során.

### **Ápolás és karbantartás:**

Tisztítsa meg ronggyal és vízzel.

A magyar használati utasítás a gyártótól kapott verzió pontos fordítása.

A kézikönyvben használt fényképek csak illusztrációk, nem egyeznek meg pontosan a termékkel.



## **Dziękujemy za zakup naszego produktu.**

Przed użyciem prosimy o zapoznanie się z niniejszą instrukcją.

### **Instrukcje Instalacji:**

Przed przystąpieniem do montażu prosimy o dokładne zapoznanie się ze wszystkimi instrukcjami i informacjami. Upewnij się, że masz wszystkie części potrzebne do zbudowania.

### **Zadbaj o swoje bezpieczeństwo.**

1. Podczas montażu należy nosić odzież ochronną i rękawice, ponieważ niektóre części mogą być ostre.
2. Podczas montażu nie wolno pozwalać dzieciom ani zwierzętom na poruszanie się po terenie budowy.

### **Opieka i utrzymanie:**

Czyścić szmatką i wodą.

Polska wersja językowa instrukcji jest dokładnym tłumaczeniem oryginalnej instrukcji producenta. Zdjęcia wykorzystane w tym podręczniku są jedynie ilustracją i nie może dokładnie dopasować produkt.

**HR**

## **Zahvaljujemo što ste kupili naš proizvod.**

Prije uporabe pročitajte ovaj priručnik.

### **Upute za instalaciju:**

Prije početka montaže pažljivo pročitajte sve upute i informacije. Provjerite imate li sve dijelove potrebne za izgradnju.

### **Vodite računa o svojoj sigurnosti.**

1. Nosite zaštitnu odjeću i rukavice prilikom sastavljanja jer neki dijelovi mogu biti oštri.
2. Djeci i kućnim ljubimcima ne smije se dopustiti da lutaju gradilištem tijekom montaže.

### **Njega i održavanje:**

Očistite krpom i vodom.

Hrvatska verzija priručnika točan je prijevod originalnih uputa proizvođača.

Slike korištene u ovom priručniku služe samo za ilustraciju i mogu se razlikovati od stvarnog proizvoda.

**SLO**

## **Zahvaljujemo se vam za nakup našega izdelka.**

Pred uporabo preberite ta priručnik.

### **Navodila za namestitev:**

Pred začetkom montaže natančno preberite vsa navodila in informacije. Prepričajte se, da imate vse dele, ki jih potrebujete za gradnjo.

### **Poskrbite za svojo varnost.**

1. Pri sestavljanju nosite zaščitno obleko in rokavice, saj so lahko nekateri deli ostri.
2. Otroci in hišni ljubljenci se med montažo ne smejo sprehajati po gradbišču.

### **Nega in vzdrževanje:**

Očistite s krpo in vodo.

Slovenska različica navodil za uporabo je natančen prevod originalnih proizvajalčevih navodil. Fotografije, uporabljene v navodilih, so samo ilustrativne in se morda ne ujemajo popolnoma z izdelkom.



**EN Installation**

**DE Montage**

**CZ Montáž**

**SK Montáž**















































**HU Összeszerelés**

**PL Montaż**

**HR Sastavljanje**

**SLO Montáž**

**EN** Parts list**DE** Teilleiste**CZ** Seznam dílů**SK** Zoznam dielov**HU** Alkatrész lista**PL** Wykaz części**HR** Popis dijelova**SLO** Seznam delov

#		mm	PCS	#		mm	PCS
GYT-A1		2195	x4	GY-18		300	x2
GY-8		160	x4	GYT-21		14	x74
GY-2a		1891	x2	GYT-C30		M8x10	x24
GY-2b		1891	x2	GYT-C31		M8	x24
GY-2c		1855	x1	GYT-C32		ST5x35	x16
GY-2d		1855	x1	GYT-C33		ST5x10	x12
GY-2e		1100	x1	GYT-C34		ST4.8x16	x148
GY-2f		1100	x1	GYT-C35		M5x19	x38
GY-2g			400	x2	GYT-C36		M5
GY-2h		800	x2	GYT-C37		M6x40	x6
GY-2i		1435.5	x2	GYT-C38		M6	x42
GY-2j		800	x1	GYT-C39		M6	x6
GY-2k		1855	x2	GYT-C40		M10	x76
GY-2l		1100	x2	GYT-C41		M4x10	x168
GY-2m		1813	x2	GYT-C42		M4	x152
GY-2n		1058	x2	GYT-C43		M4	x16
GY-2o		1751.5	x2	GYT-C44			x76
GY-2p		996.5	x2	GYT-C45		M8x70	x16
GY-2q		1402	x4	GYT-C15		1843	x38
GY-13		110	x8				
GY-14		100	x4				
GY-20		110	x2				
GY-15		231	x2				
GY-16		861	x2				
GY-22		127	x1				
GY-23		120	x1				
GY-23a		120	x1				
GYT-10		112	x18				
GYT-10a		112	x38				
GYT-10b		112	x18				
GYT-10c		112	x1				
GYT-10d		112	x1				
GYT-12		37	x70				
GYT-12a		97	x2				
GYT-12c		66	x4				



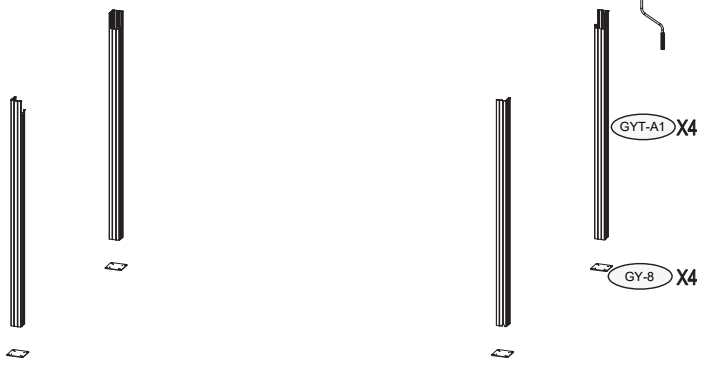
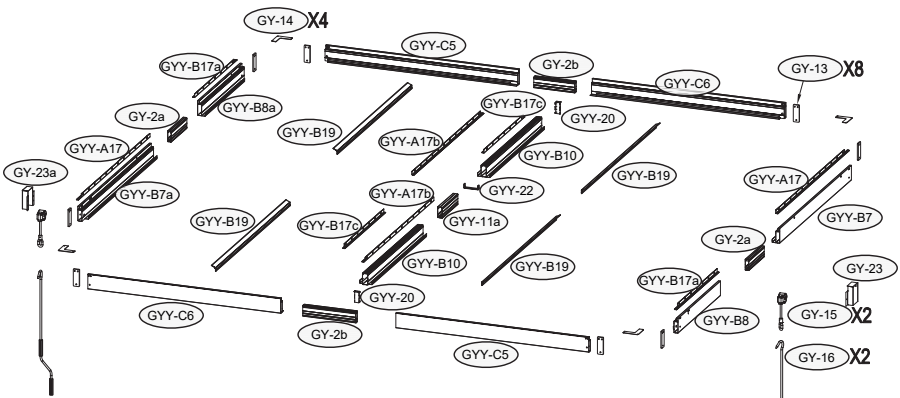
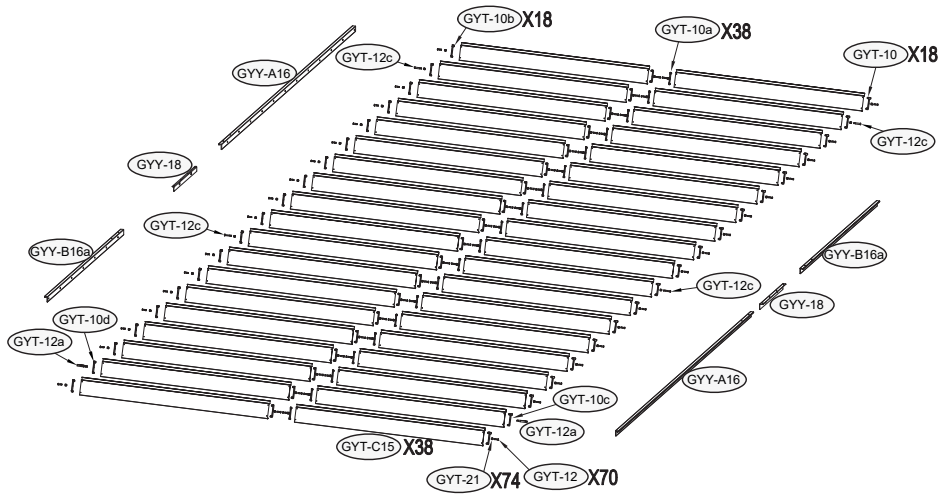

**EN** Tools you will need

**DE** Werkzeuge, die Sie brauchen

**CZ** Nástroje, které budete potřebovat

**SK** Nástroje, ktoré budete potrebovať

**HU** Szükséges eszközök és szerszámok

**PL** Przystroje i narzędzia, które będą potrzebne

**HR** Alati koji će vam trebati

**SLO** Orodja, ki jih boste potrebovali

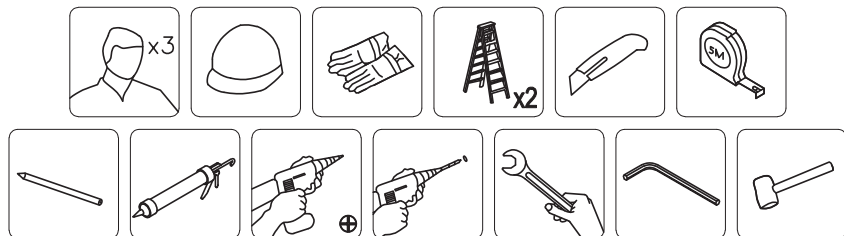

**EN** Dimensions

**DE** Abmessungen

**CZ** Rozměry

**SK** Rozmery

**HU** Méretek

**PL** Wymiary

**HR** Dimenzije

**SLO** Dimenzije

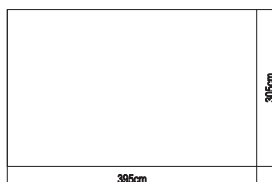
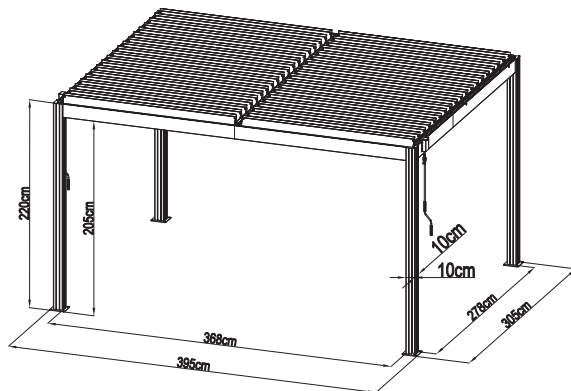

**EN** Assembly instructions

**DE** Montageanleitung

**CZ** Návod k montáži

**SK** Návod k montáži





**HU** Szerelési útmutató

**PL** Instrukcja montażu

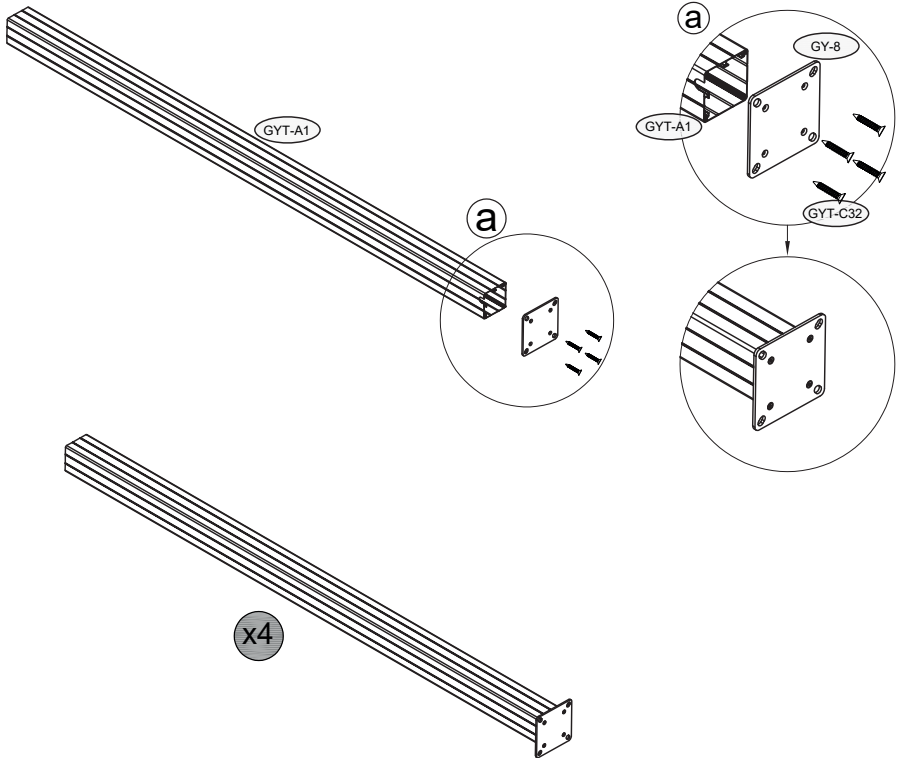
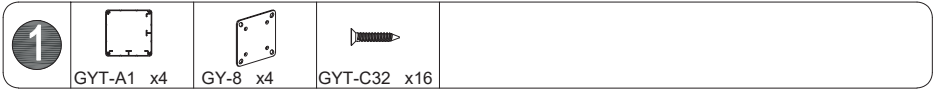

**HR** Upute za montažu

**SL** Navodila za namestitev



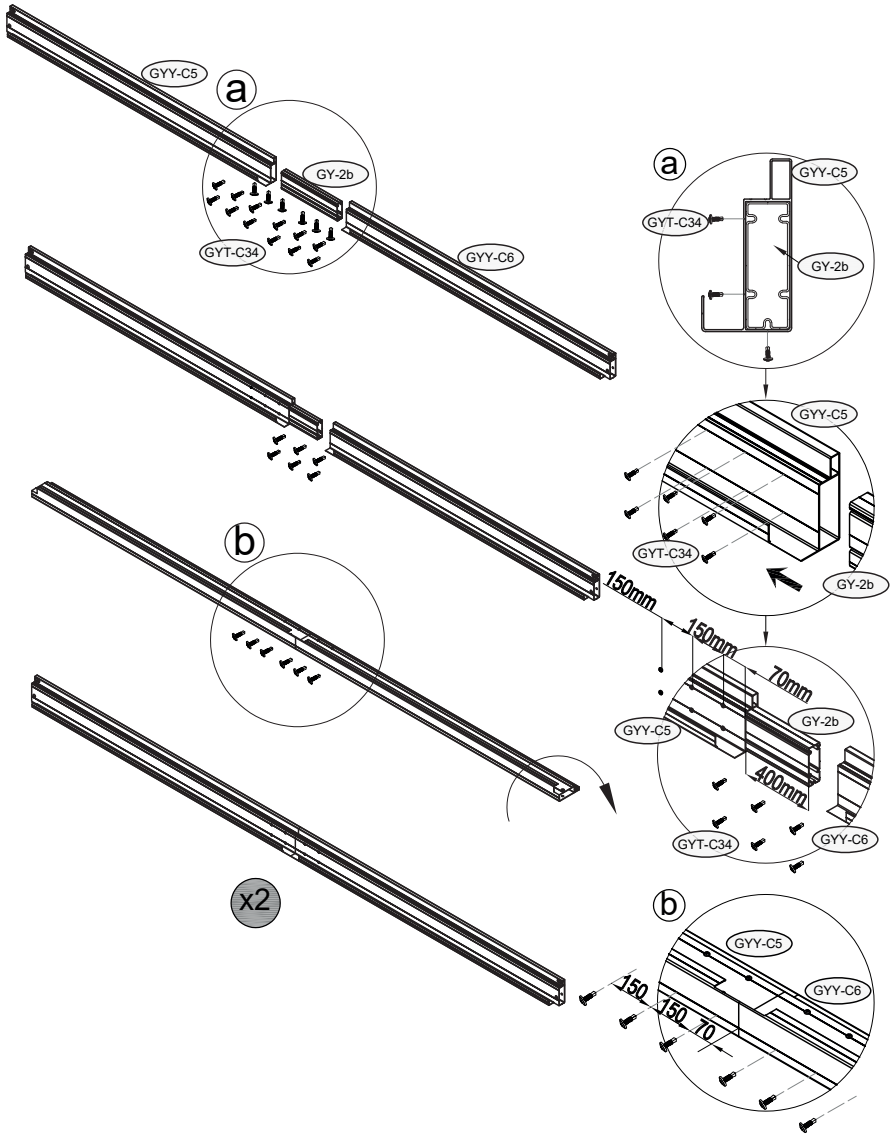



<b>2</b>					
	GYY-C5 x2	GYY-C6 x2	GY-2b x2	GYT-C34 x36	

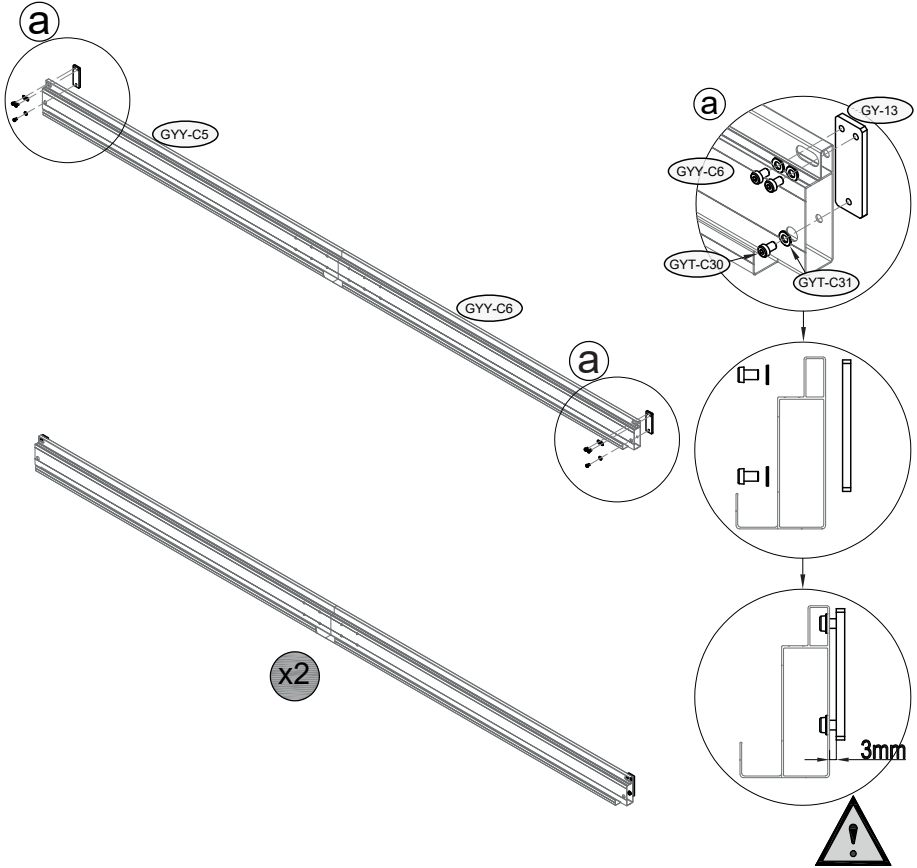

<b>3</b>	 GY-13 x4	 GYT-C30 x12	 GYT-C31 x12	
----------	---	--	--	--



<b>4</b>	 GY-Y-B7 x1	 GY-Y-B8 x1	 GY-2a x1	 GY-T-C34 x12	
----------	---	---	---	---	--

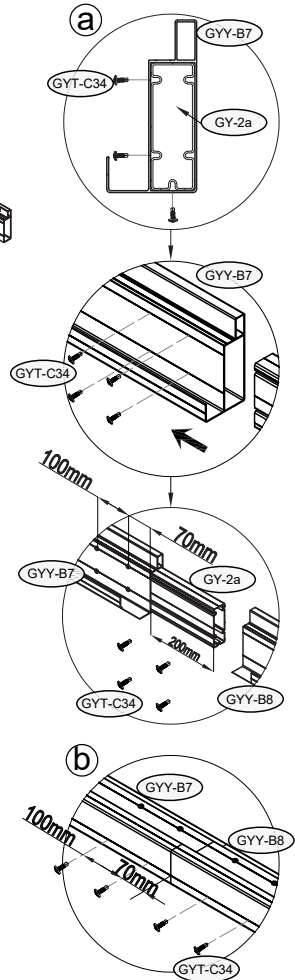
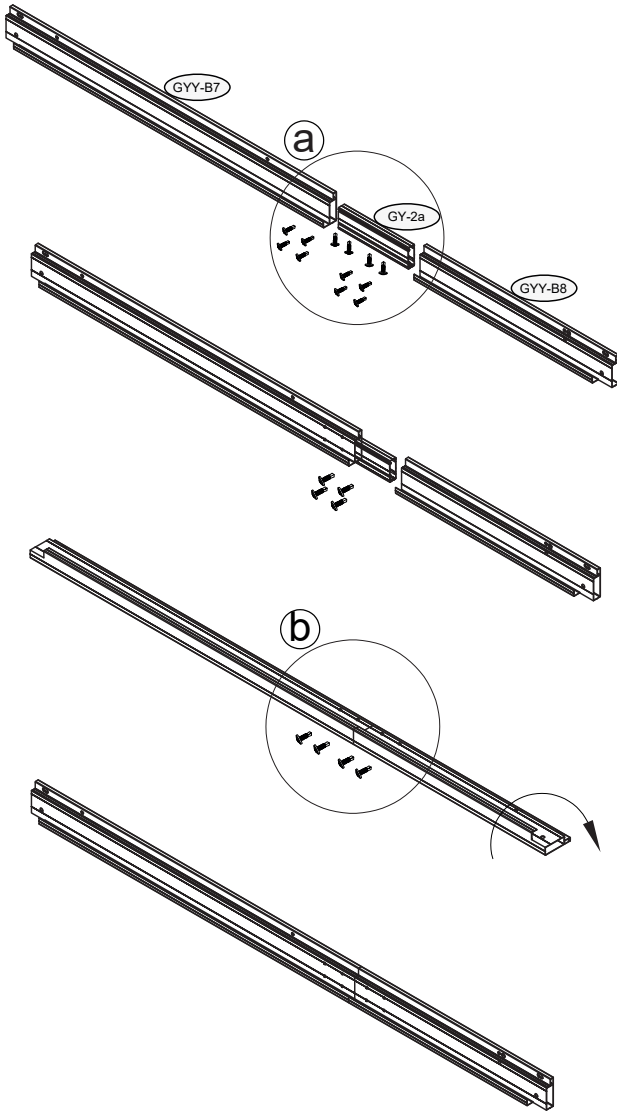

<p><b>5</b></p>	 <p>GY-13 x2</p>	 <p>GYT-C30 x6</p>	 <p>GYT-C31 x6</p>	
-----------------	---	---	---	--

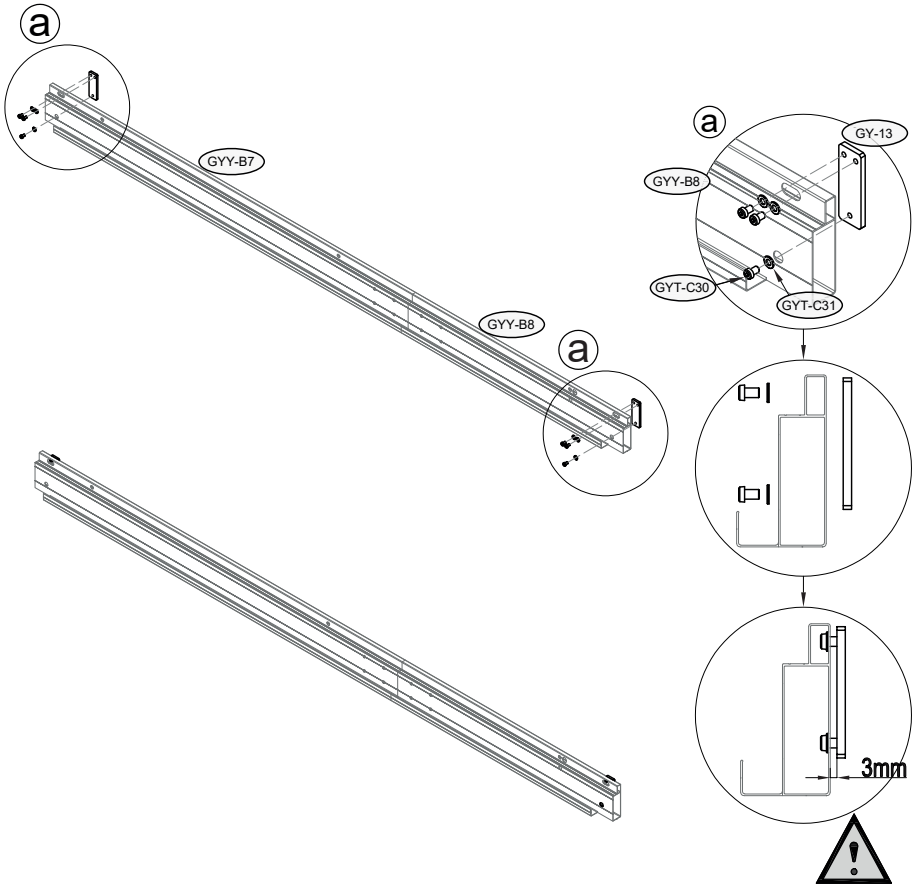



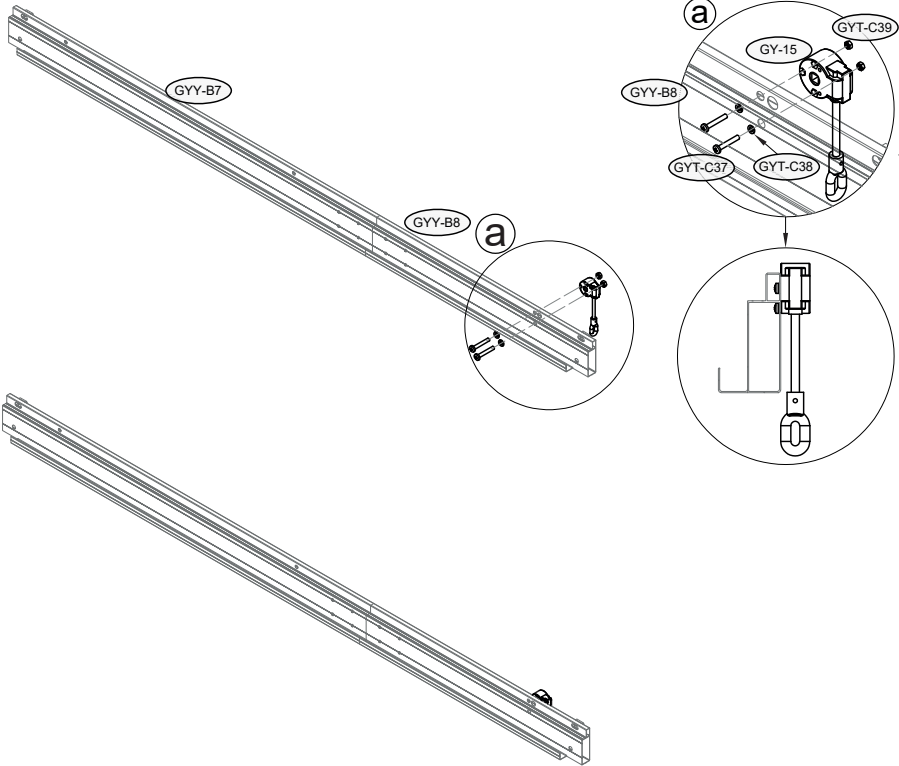

<b>6</b>	 GY-15 x1	 GYT-C37 x2	 GYT-C38 x2	 GYT-C39 x2	
----------	---	---	---	---	--



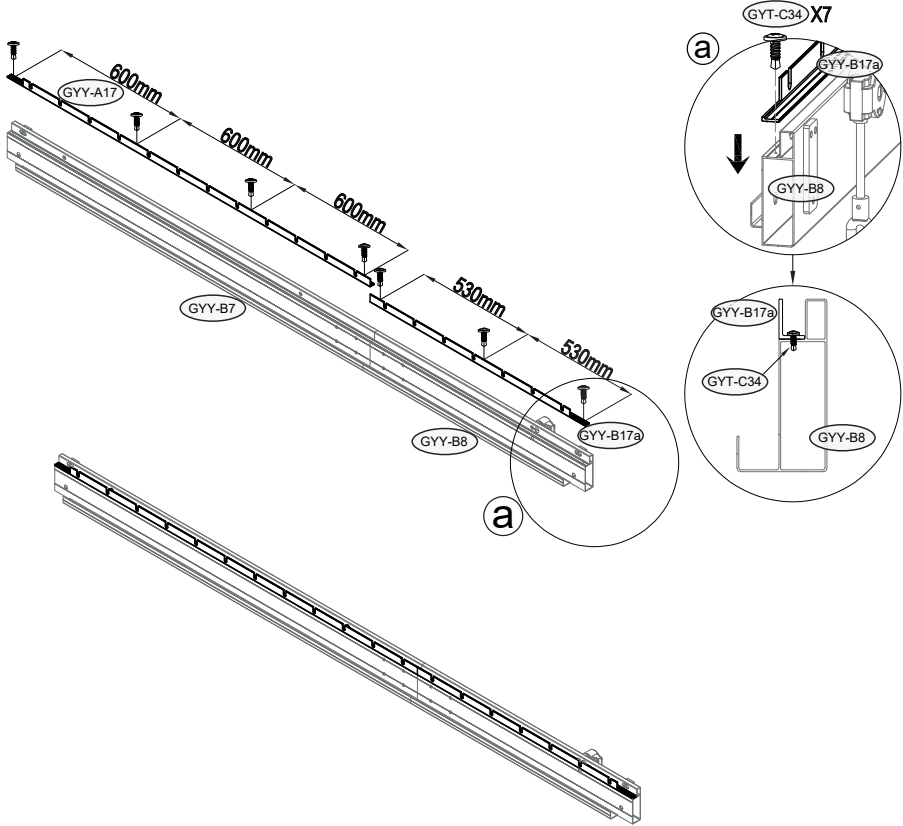

<b>7</b>	 GYY-A17 x1	 GYY-B17a x1	 GYT-C34 x7	
----------	---	--	---	--



<b>8</b>	 GY-Y-B7a x1	 GY-Y-B8a x1	 GY-2a x1	 GY-T-C34 x12	
----------	--	--	---	---	--

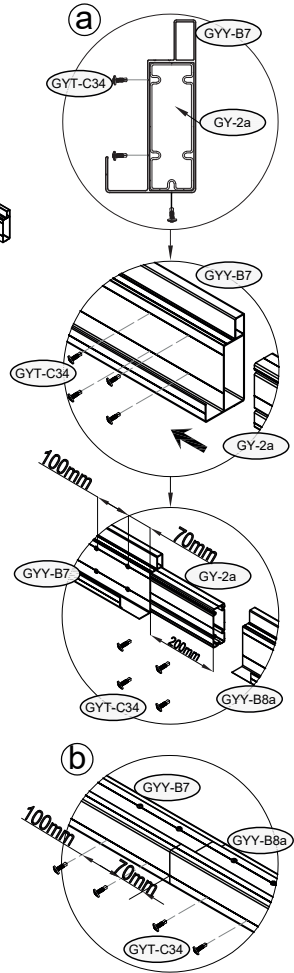
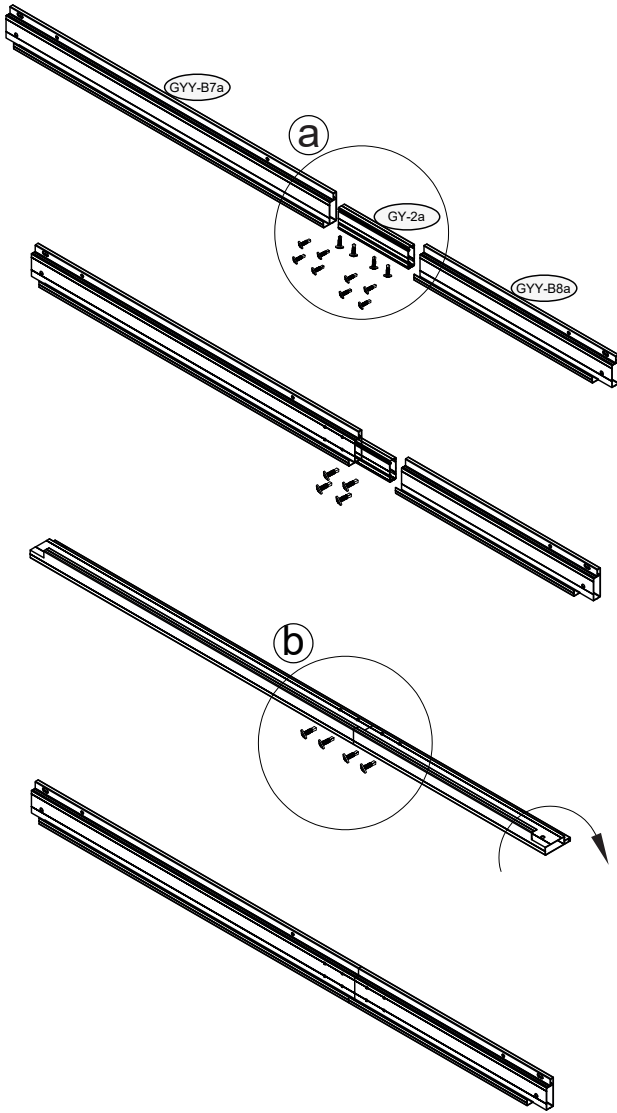

<b>9</b>	 GY-13 x2	 GYT-C30 x6	 GYT-C31 x6	
----------	---	---	---	--

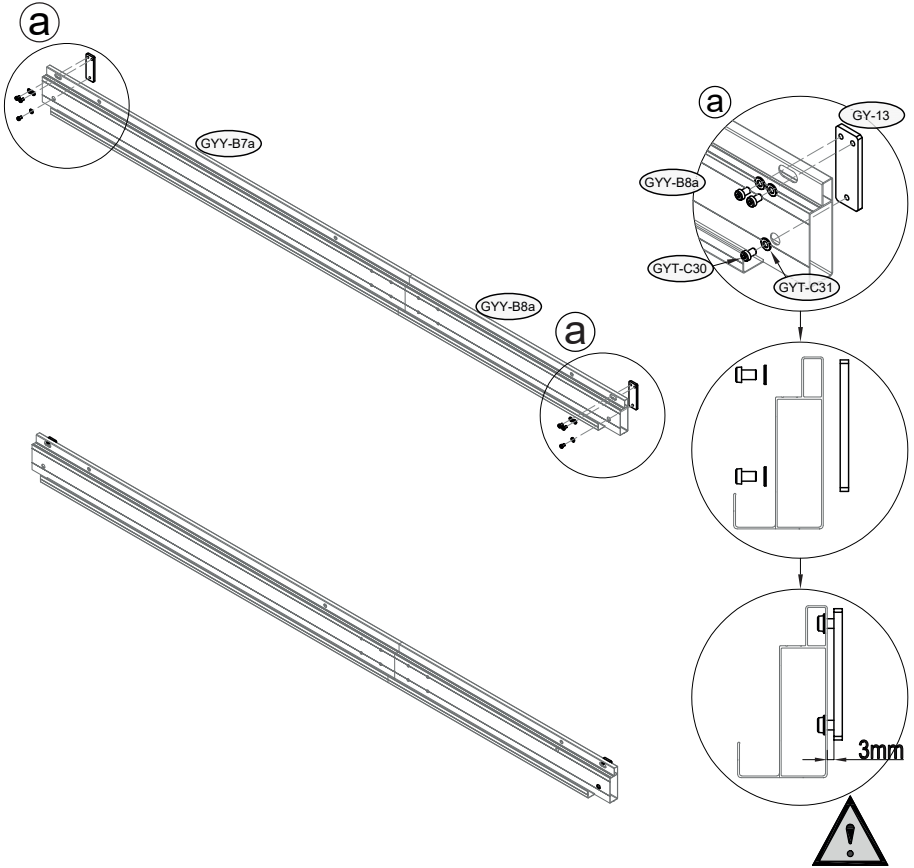

<p><b>10</b></p>	 <p>GY-15 x1</p>	 <p>GYT-C37 x2</p>	 <p>GYT-C38 x2</p>	 <p>GYT-C39 x2</p>	
------------------	---	---	---	---	--

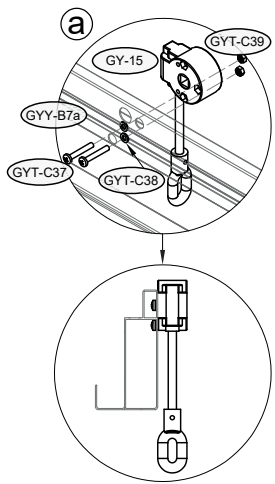
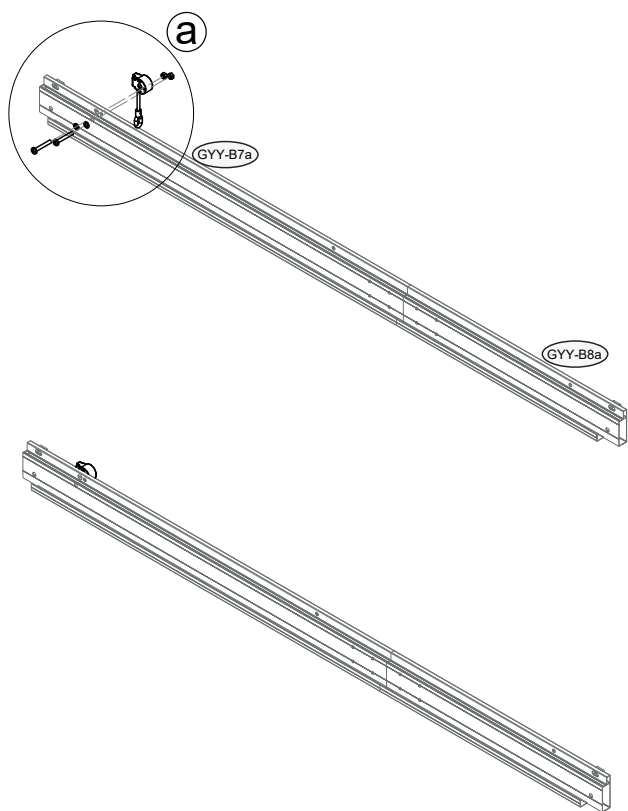

	 GYY-A17 x1	 GYY-B17a x1	 GYT-C34 x7	
---	---	--	---	--

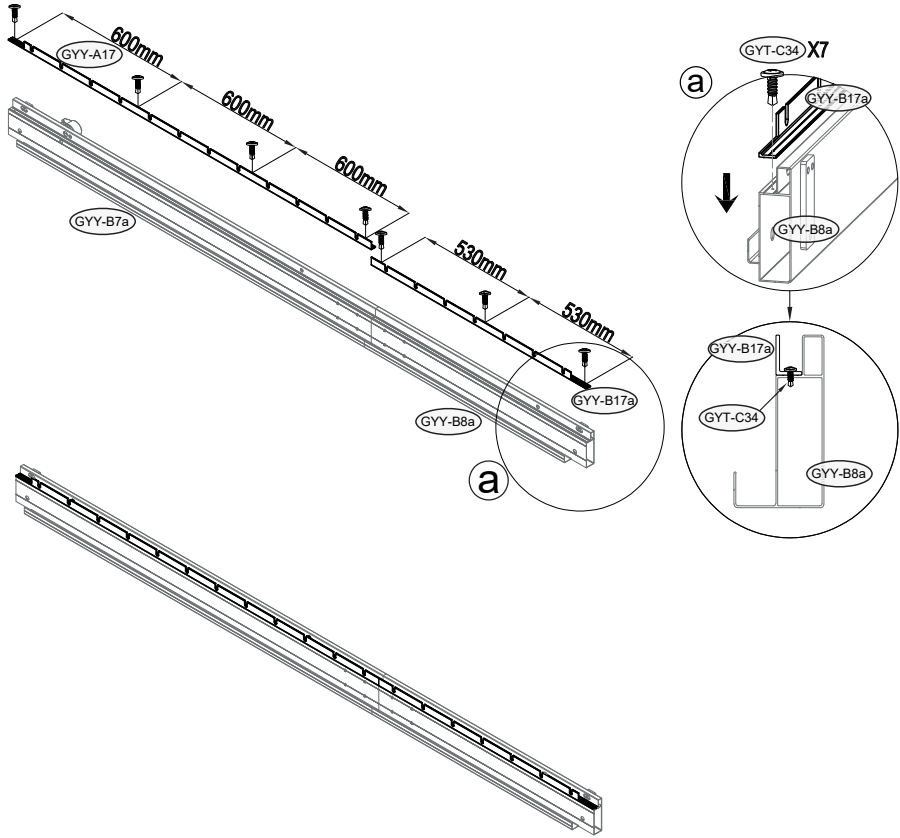

12



GYY-B10 x2



GYY-11a x1



GYT-C34 x36

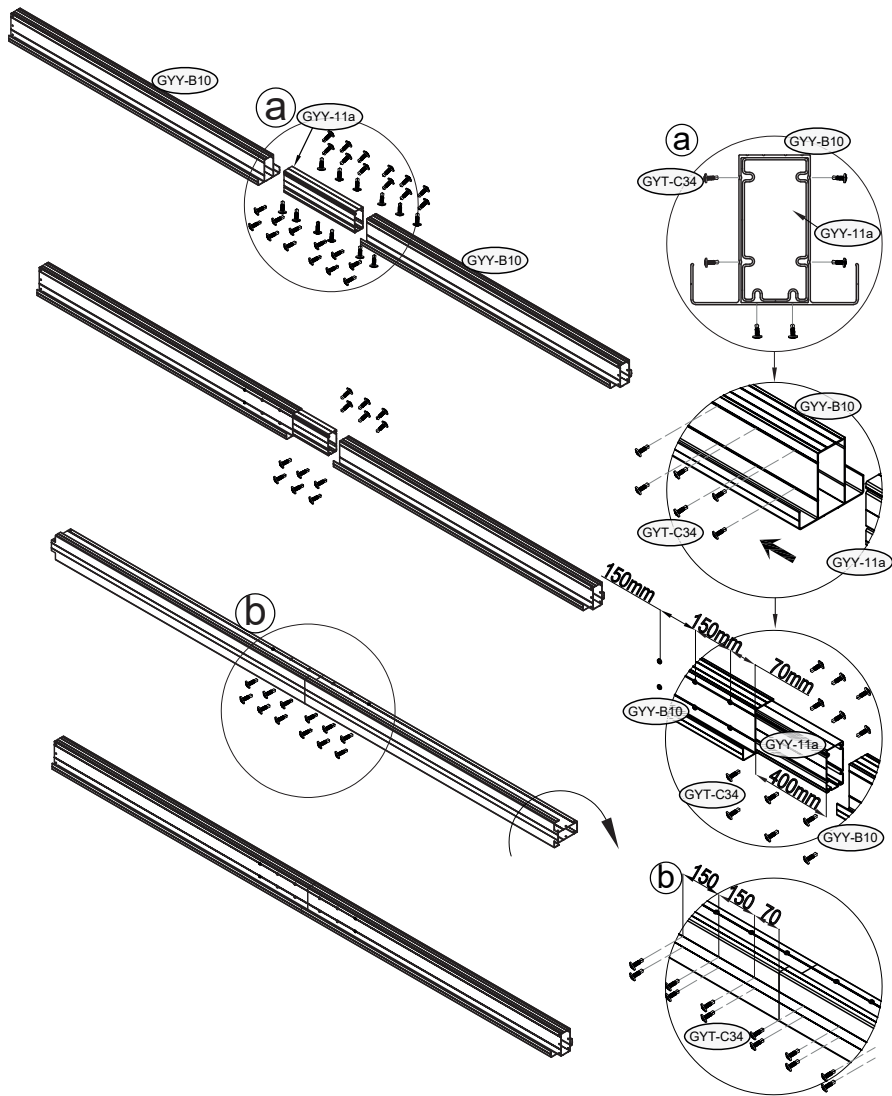

13

		
GY-Y-A17b x2	GY-Y-B17c x2	GY-T-C34 x14

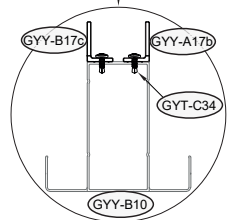
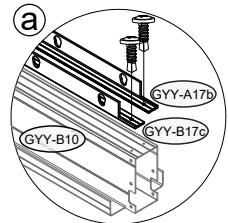
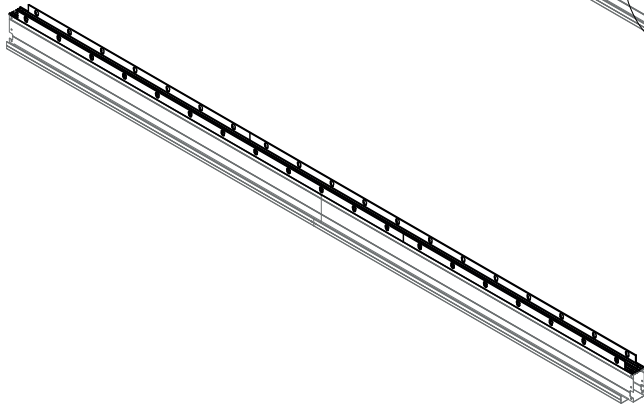
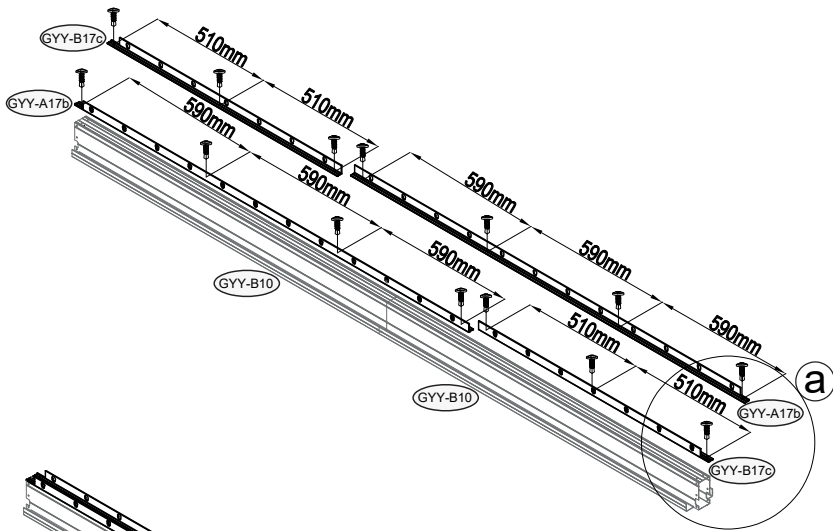

14	 GY-Y-20 x2	 GY-T-C34 x12	
----	---	---	--

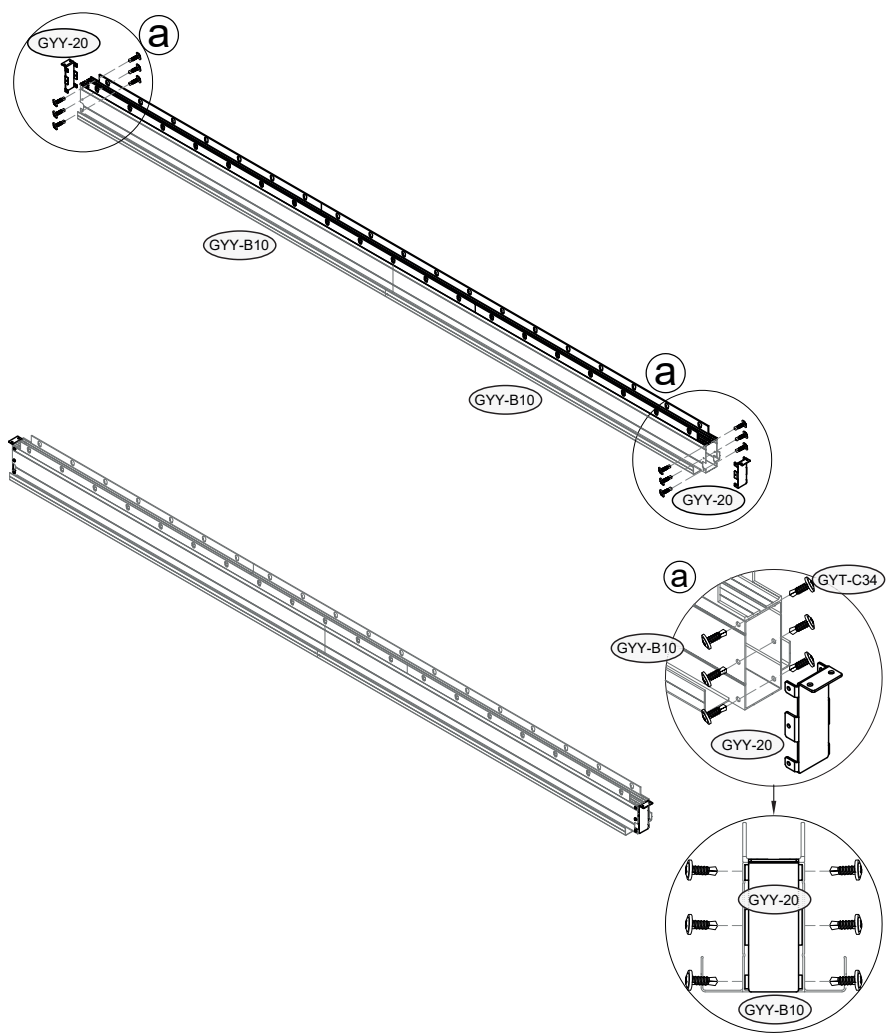



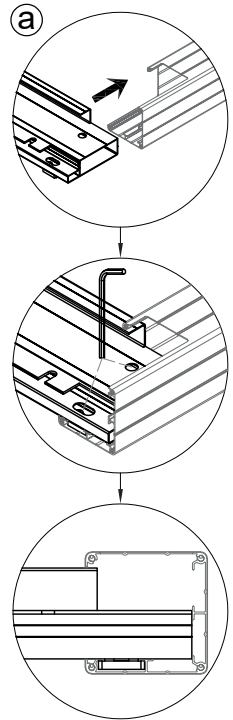
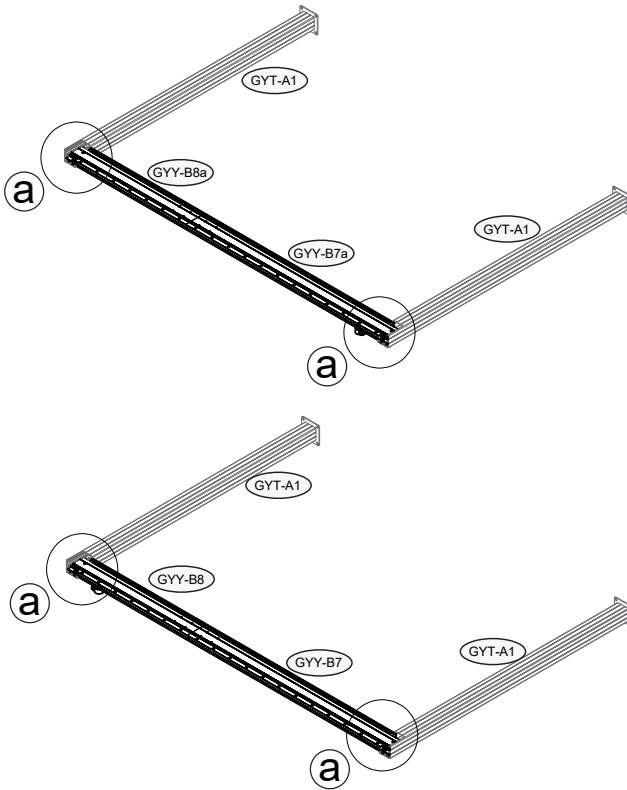

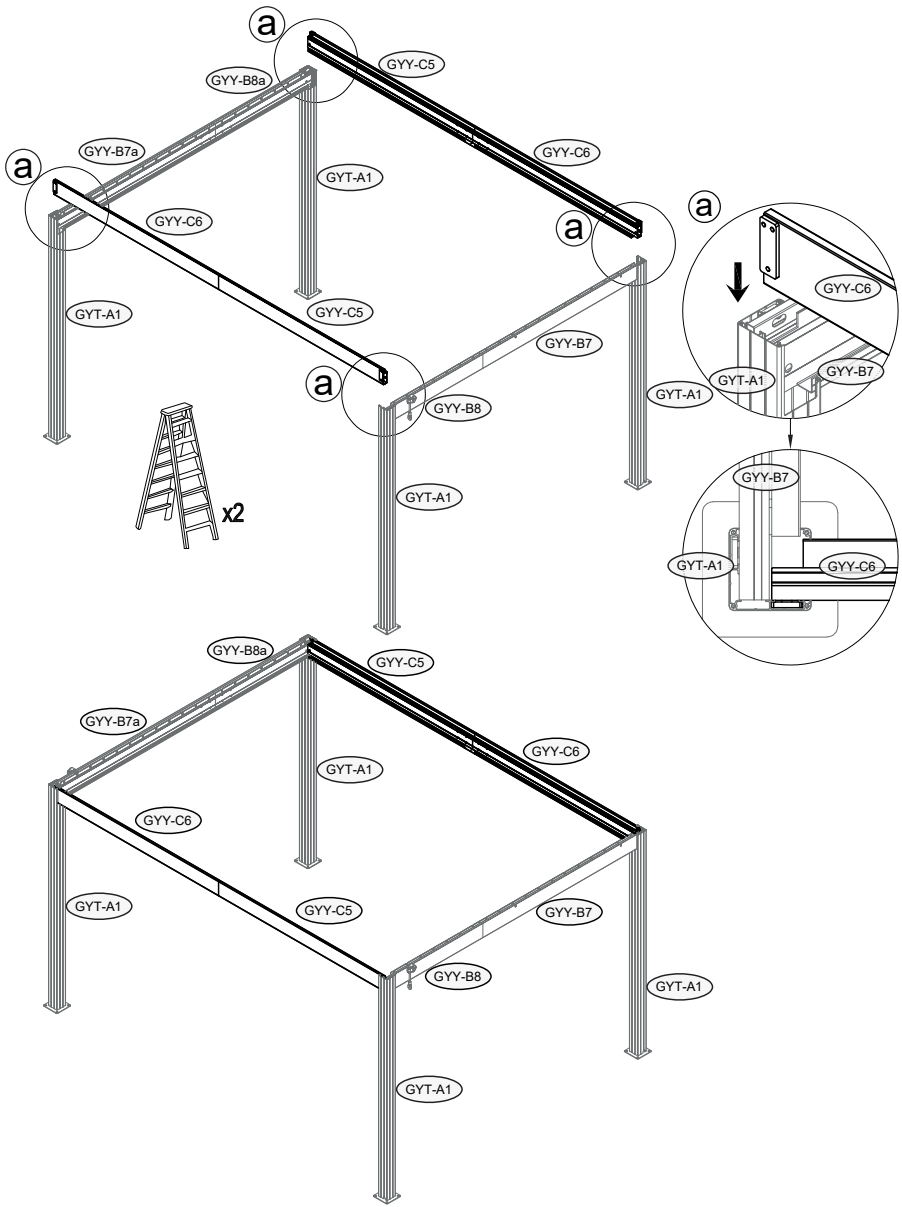

17

GYT-C45 x16

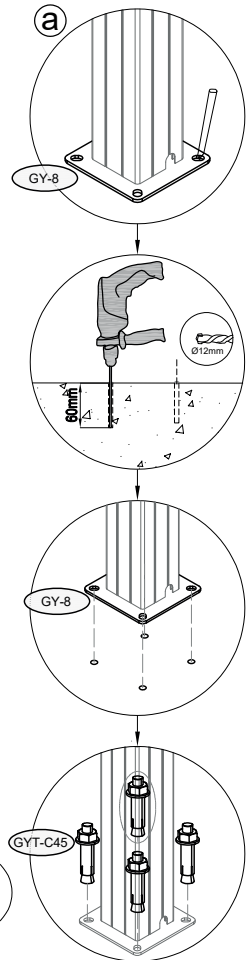
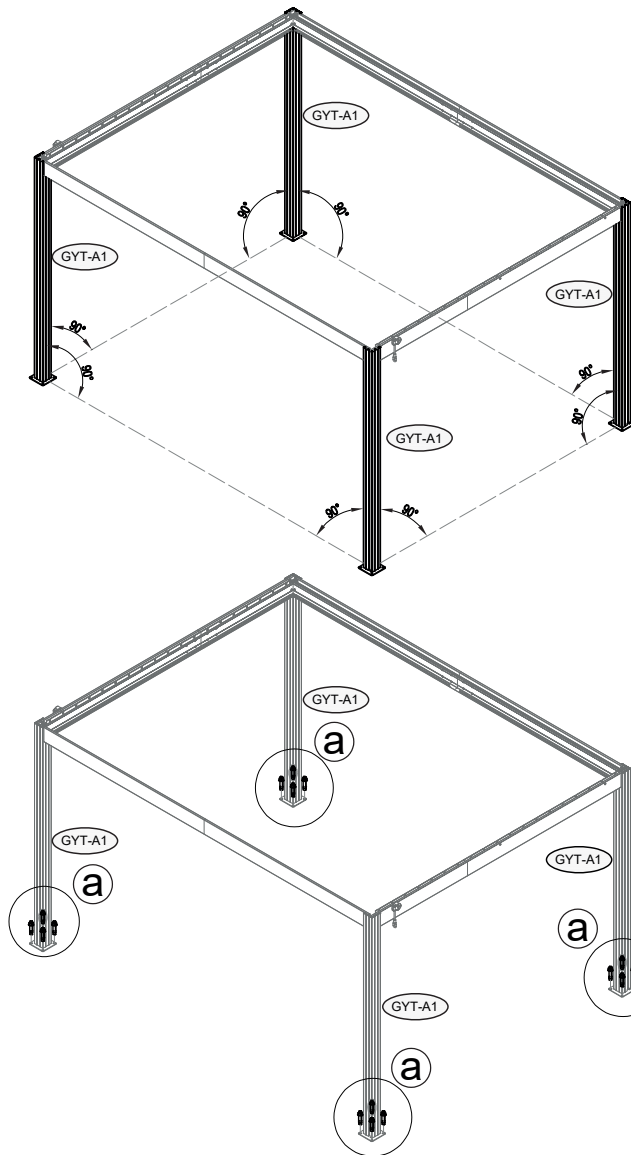



18

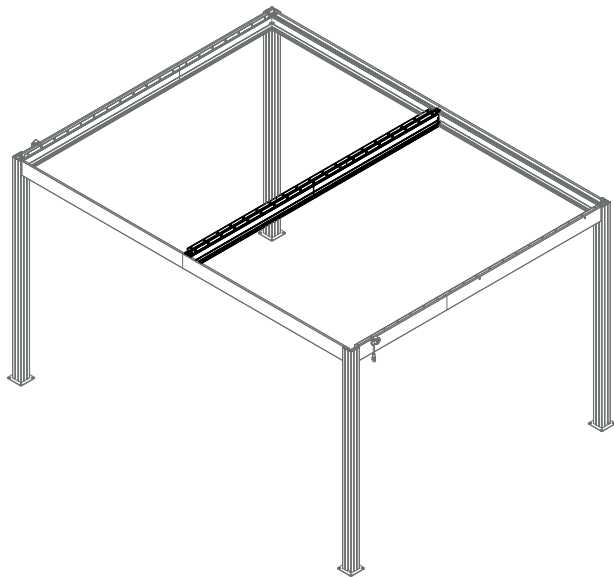
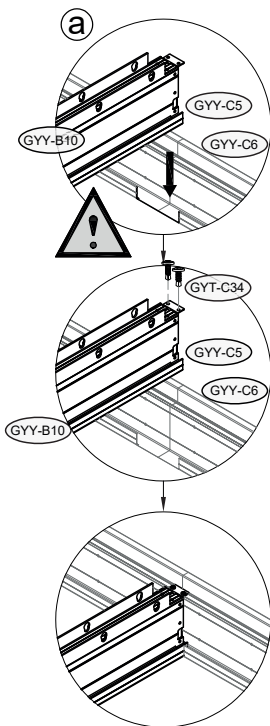
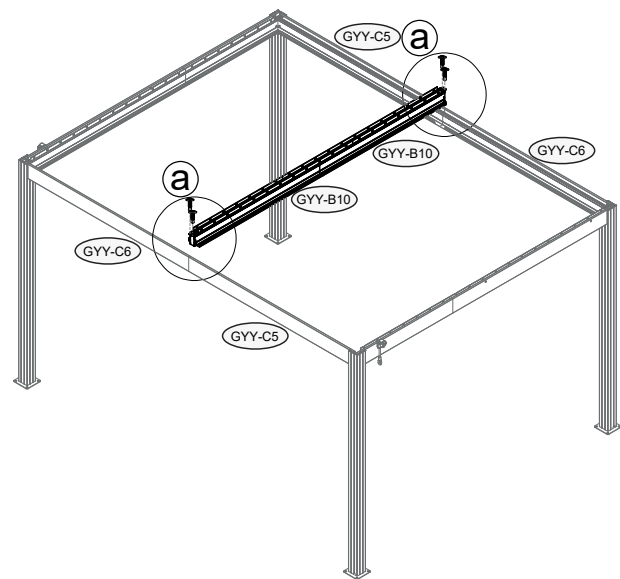

GYT-C34 x4



<p>19</p>	 <p>GYY-22 x1</p>	 <p>GYT-C41 x4</p>	 <p>GYT-C43 x4</p>	
-----------	--	---	---	--

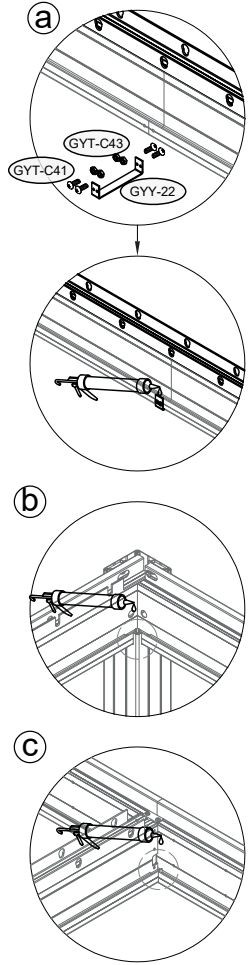
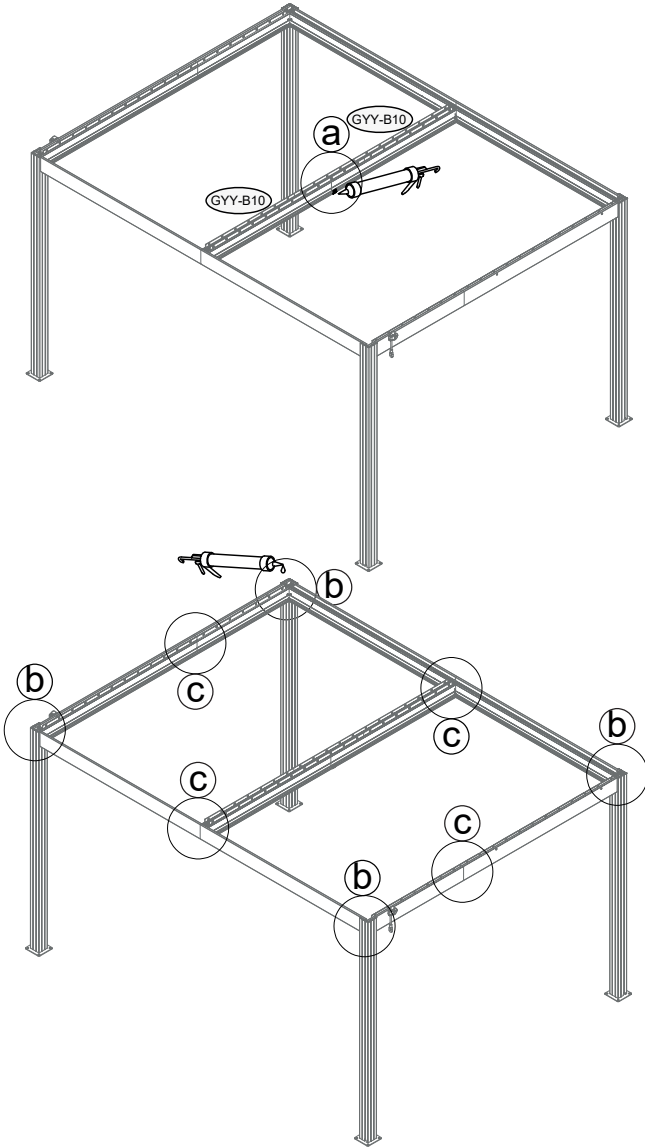



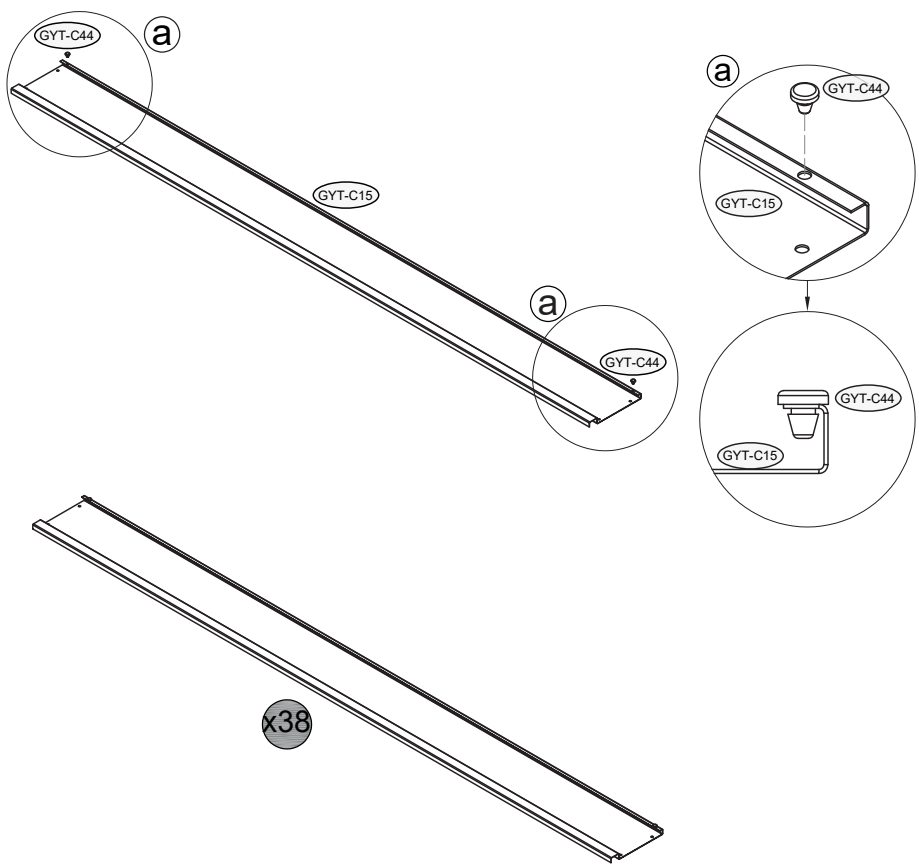

<b>20</b>			
	GYT-C15 x38	GYT-C44 x76	

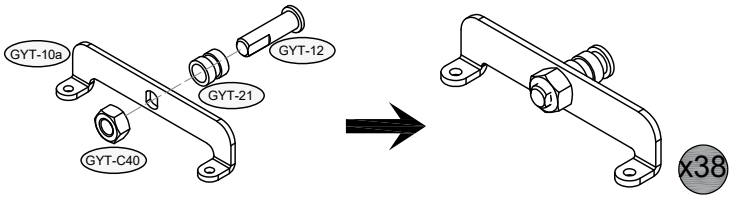

<b>21</b>					
	GYT-10a x38	GYT-12 x38	GYT-21 x38	GYT-C40 x38	



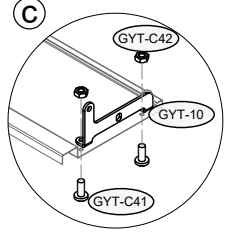
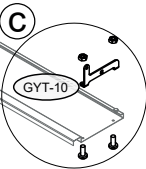
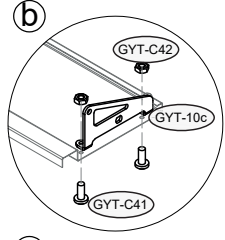
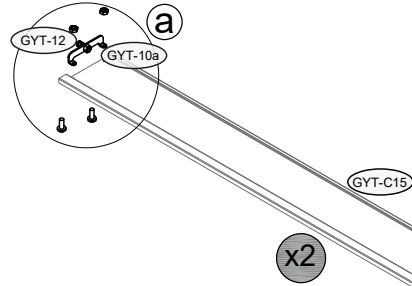
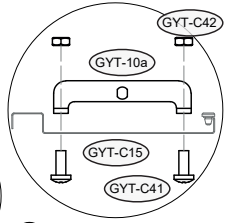
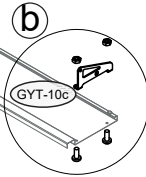
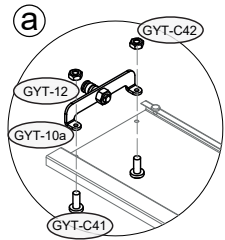
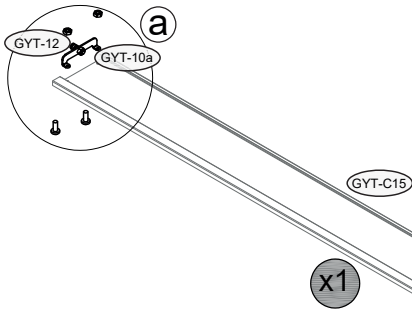

			
GYT-10c x1	GYT-10 x2	GYT-C41 x12	GYT-C42 x12



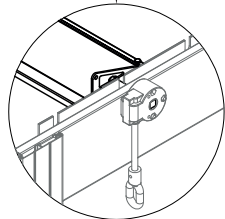
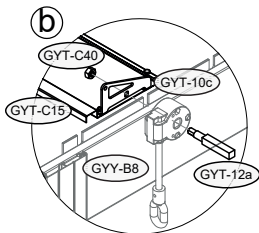
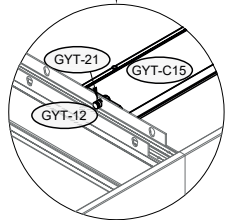
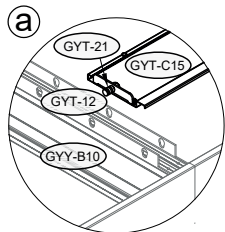
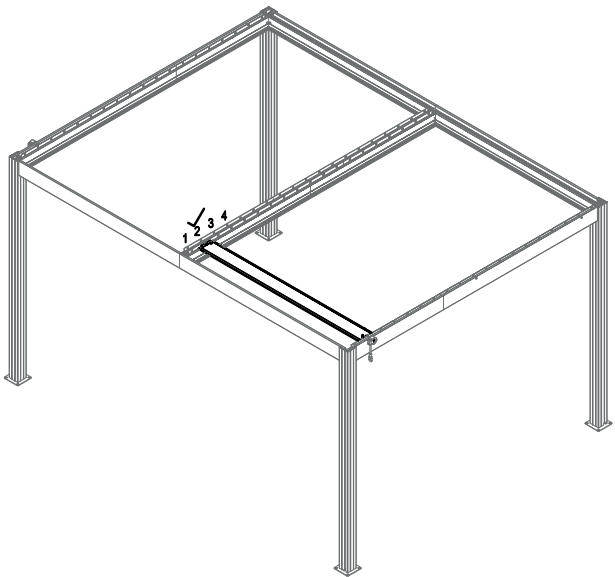
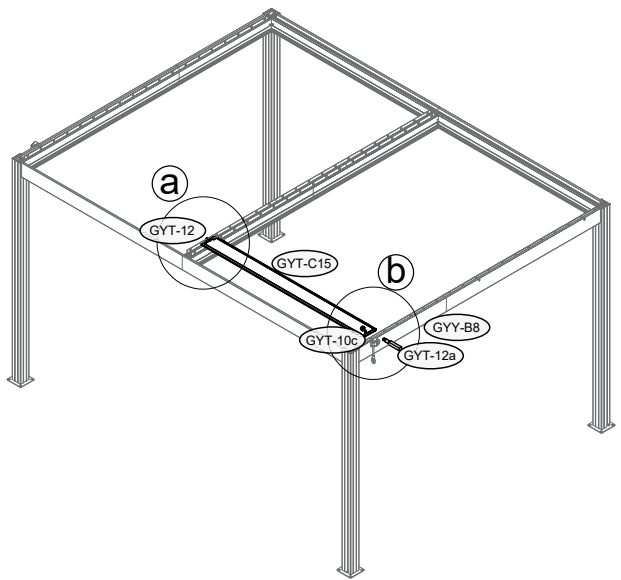
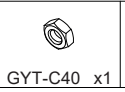
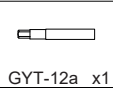



22



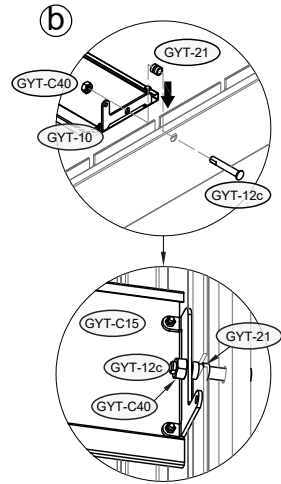
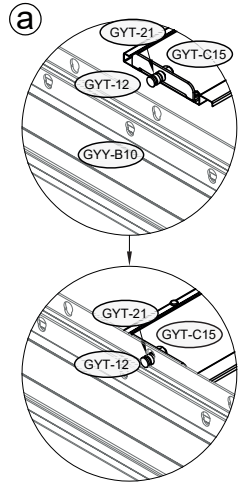
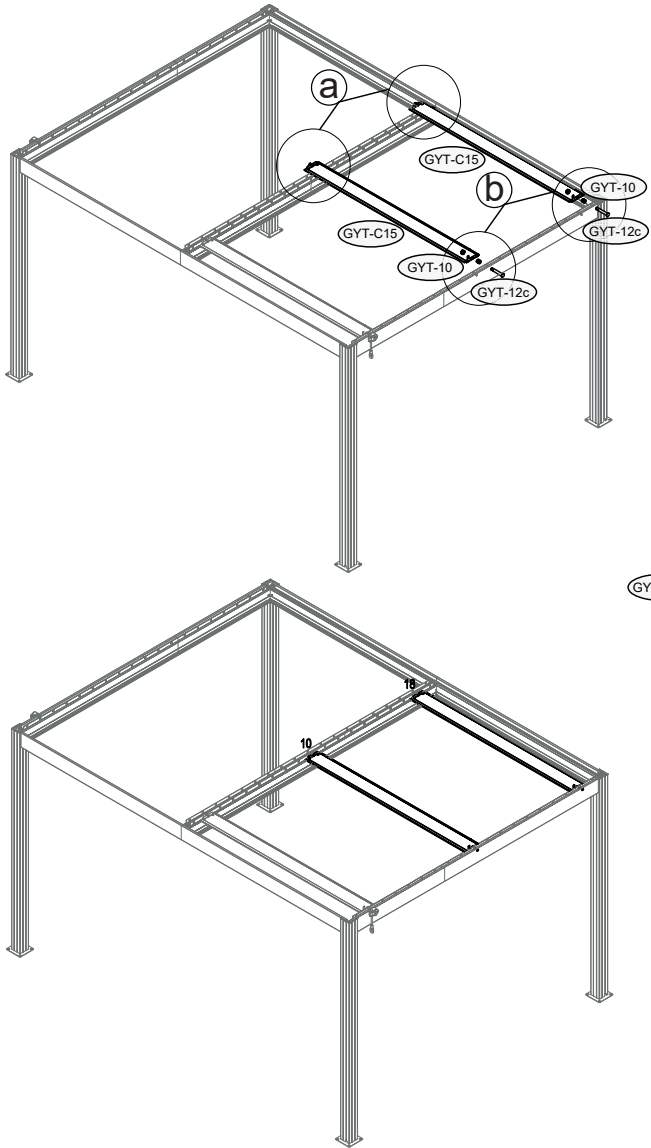



<b>23</b>	 GYT-12c x2	 GYT-21 x2	 GYT-C40 x2	
-----------	--	---	--	--

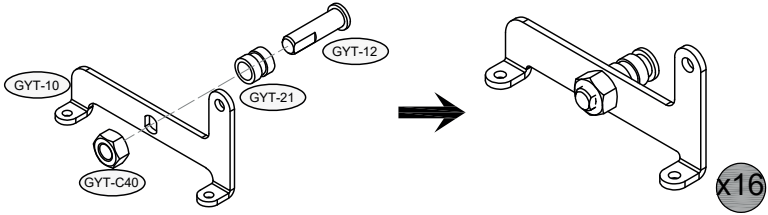

<b>24</b>	 GYT-10 x16	 GYT-12 x16	 GYT-21 x16	 GYT-C40 x16	
-----------	---	---	---	--	--



 GYT-C41 x64	 GYT-C42 x64
--	--

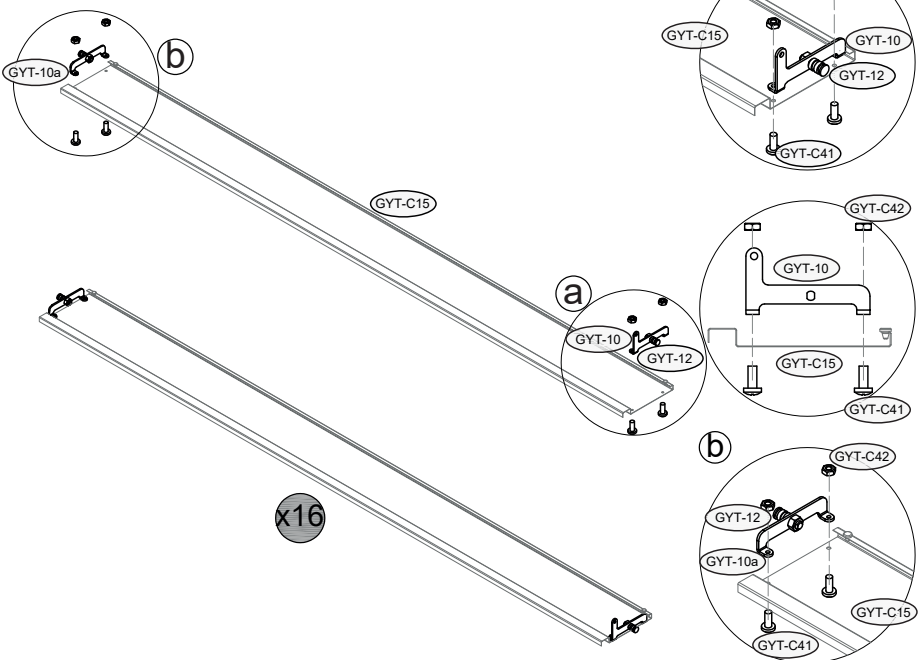

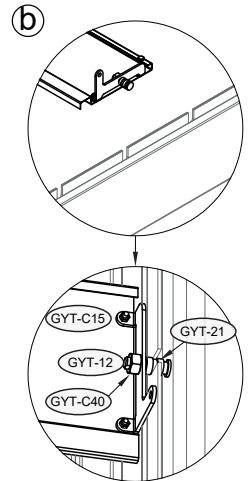
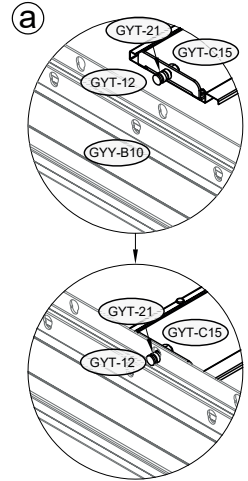
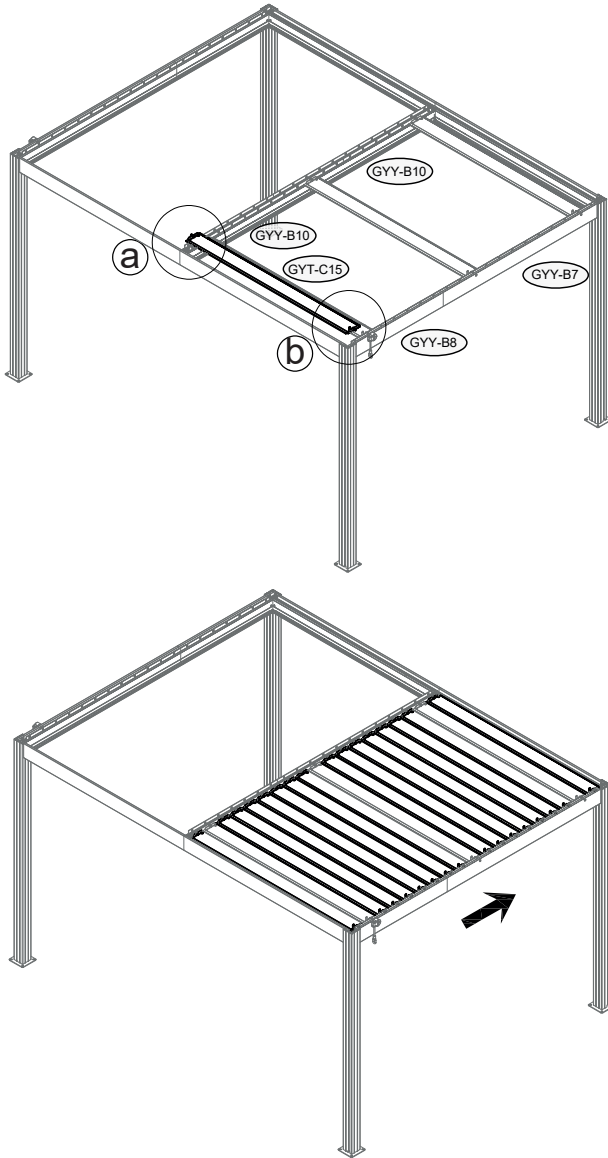

<b>26</b>	 GYT-10d x1	 GYT-10b x2	 GYT-C41 x12	 GYT-C42 x12	
-----------	--	--	---	---	--

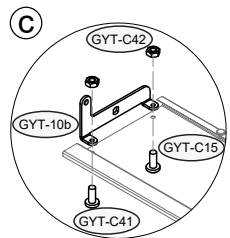
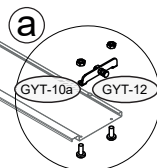
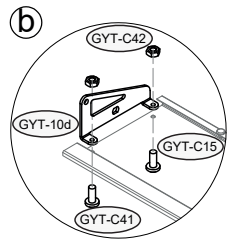
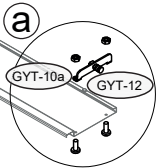
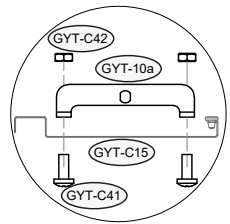
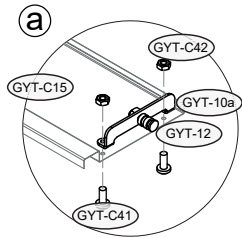
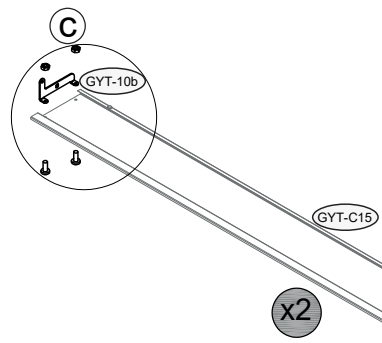
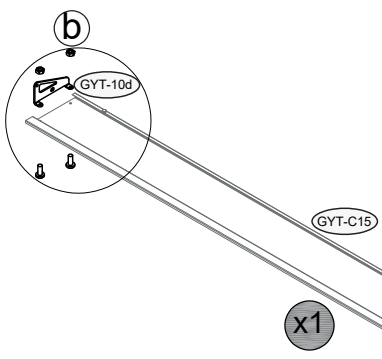

 27	 GYT-12a x1	 GYT-C40 x1
---	---	---

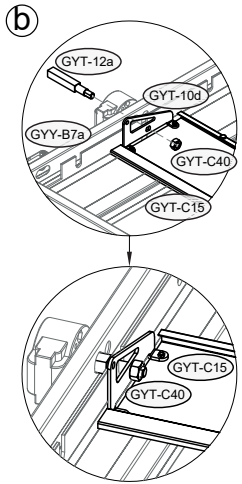
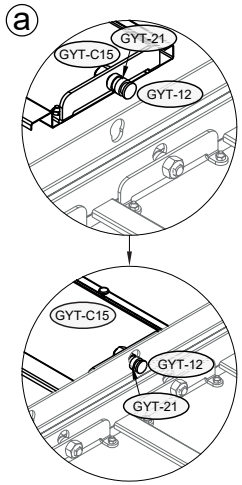
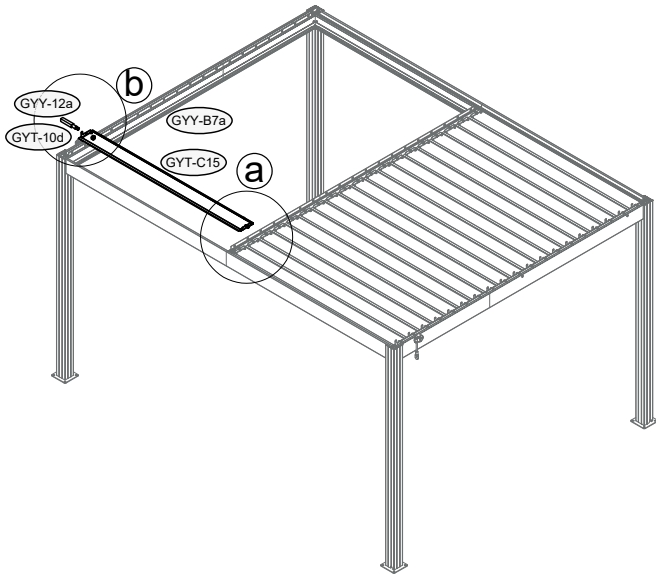

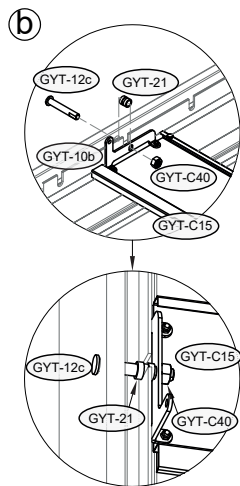
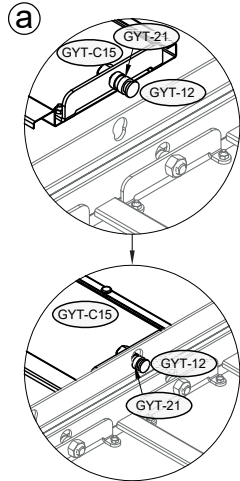
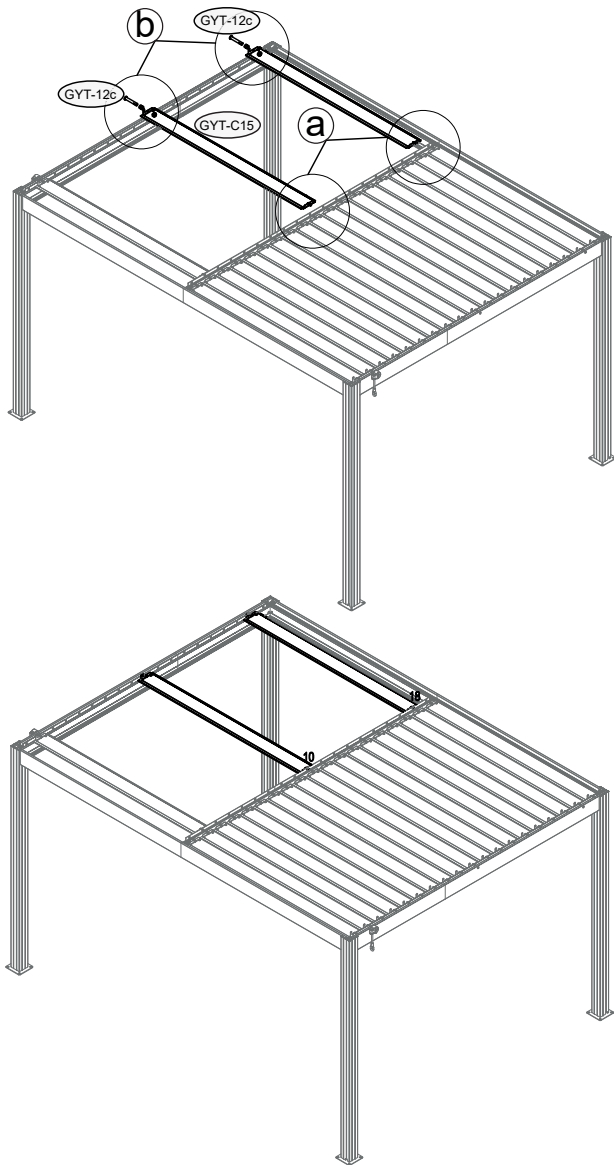
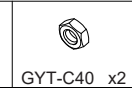
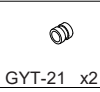
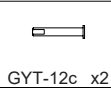

28

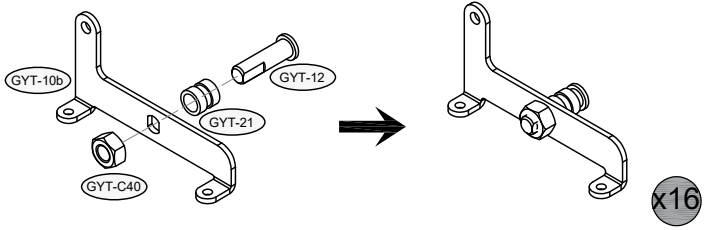

<b>29</b>	 GYT-10b x16	 GYT-12 x16	 GYT-21 x16	 GYT-C40 x16	
-----------	--	---	---	--	--





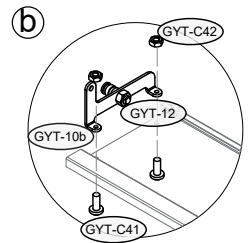
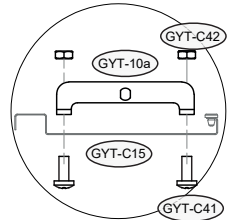
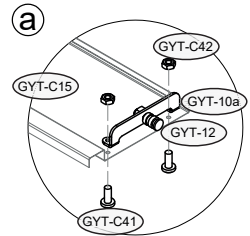
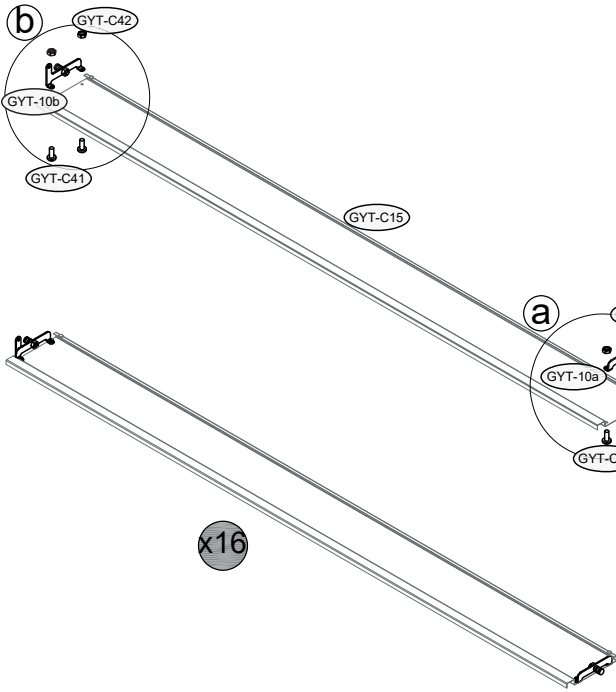

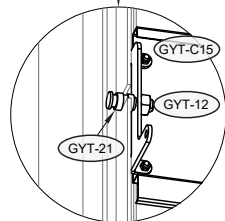
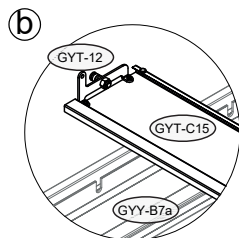
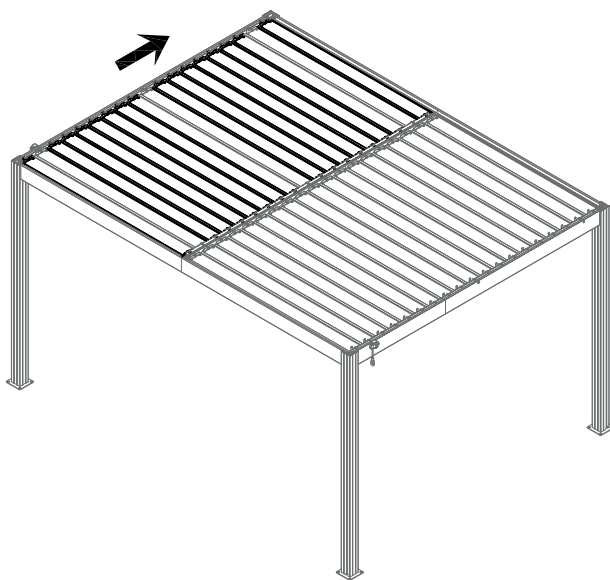
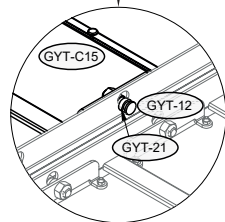
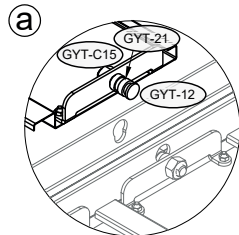
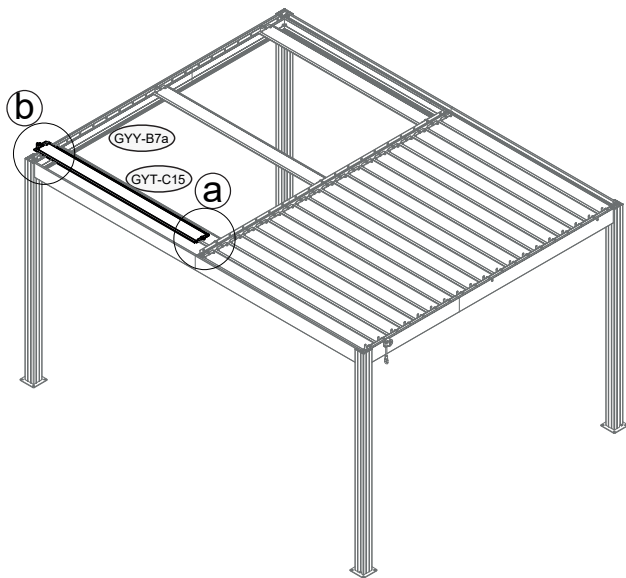
 GYT-C41 x64	 GYT-C42 x64
--	--







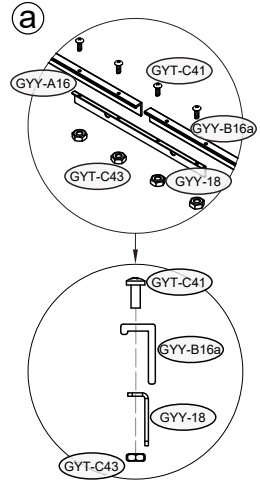
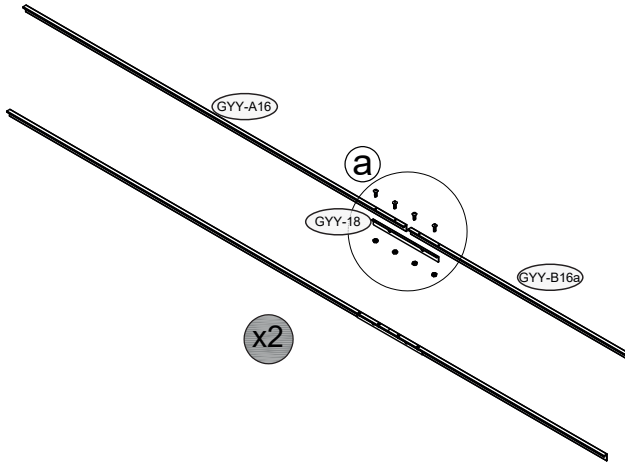

<b>31</b>	 GYY-A16 x2	 GYY-B16a x2	 GYY-18 x2	 GYT-C41 x8	 GYT-C43 x8
-----------	--	---	---	--	--



 GYT-C35 x38	 GYT-C38 x38	 GYT-C36 x38
---	---	---

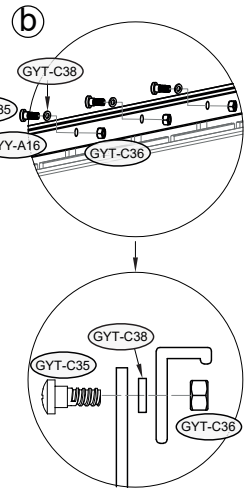
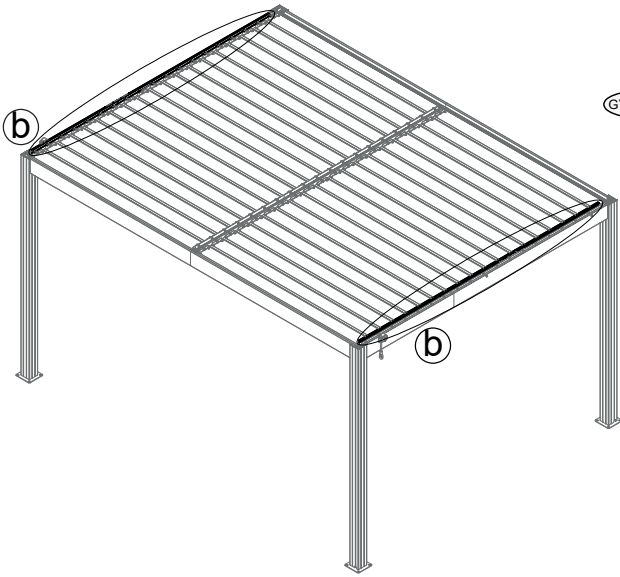

32



GY-14 x4







GYT-C33 x12

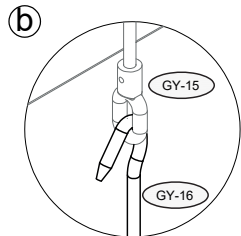
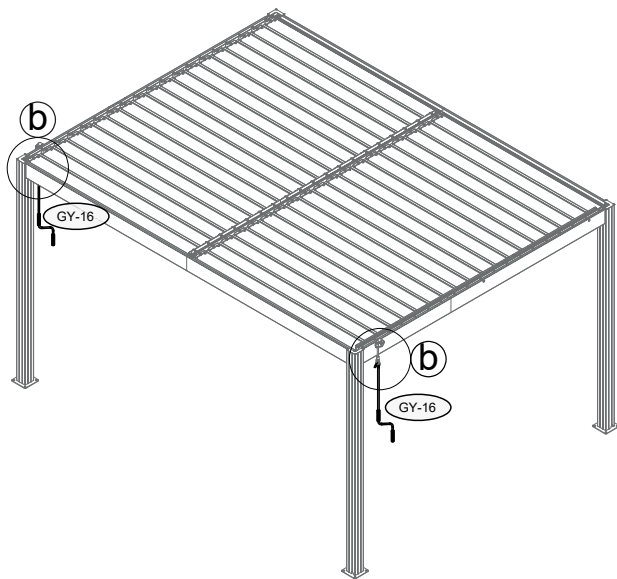
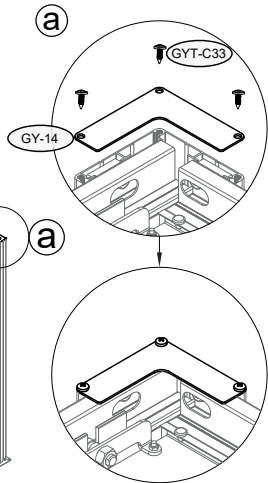
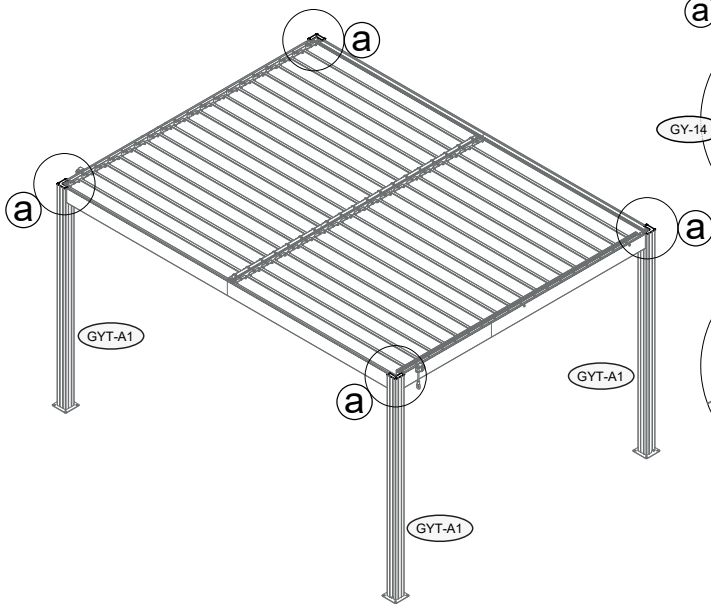





GY-16 x2

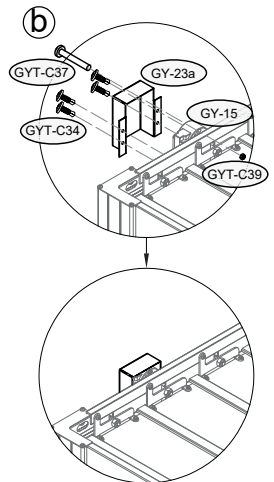
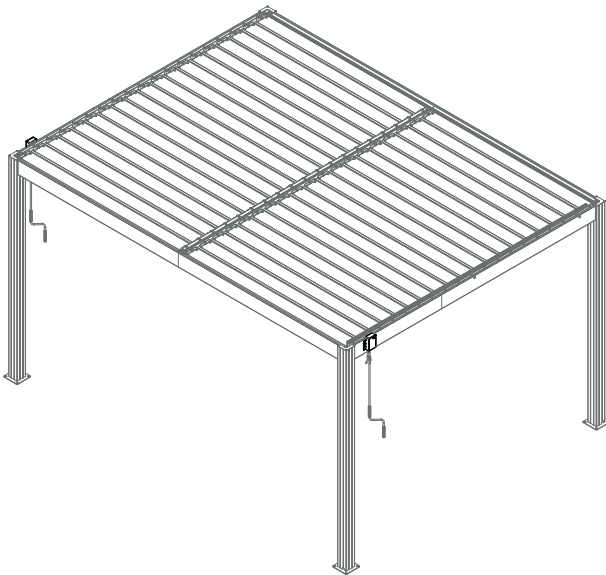
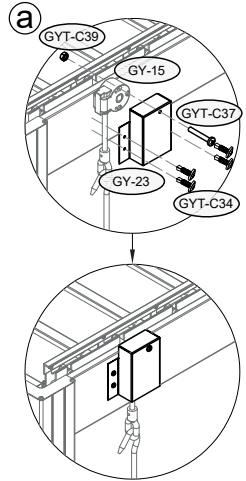
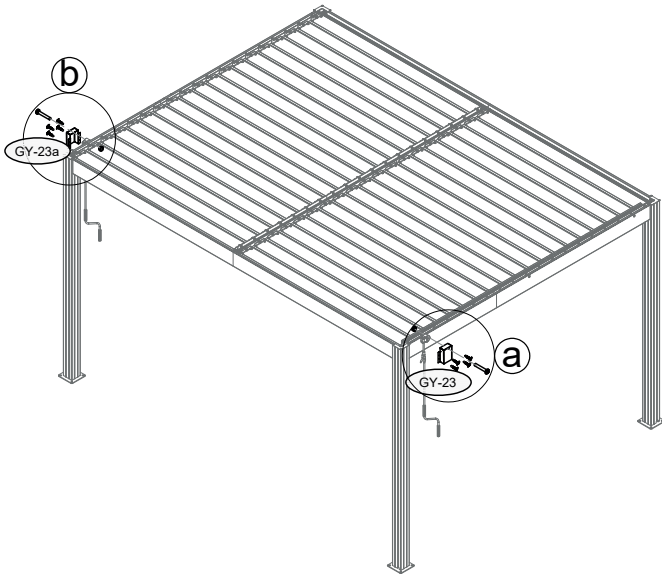

32

<b>33</b>					
	GY-23 x1	GY-23a x1	GYT-C37 x2	GYT-C39 x2	GYT-C34 x8



<b>34</b>				
	GY-Y-B19 x4	GY-T-C41 x4	GY-T-C43 x4	

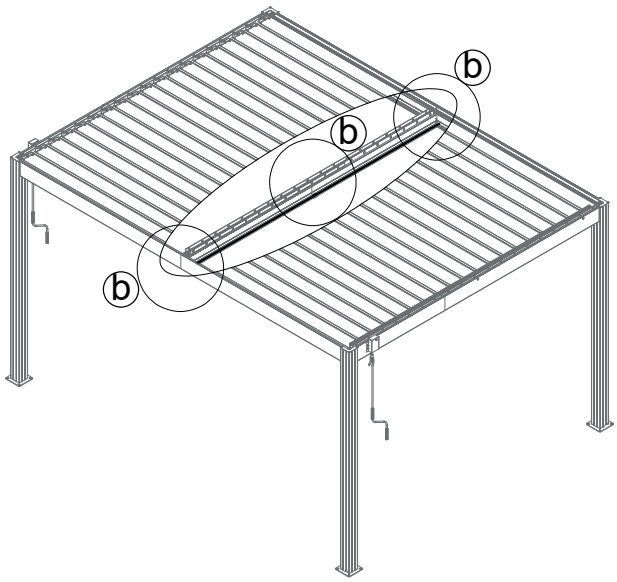
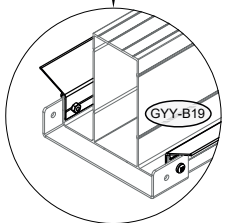
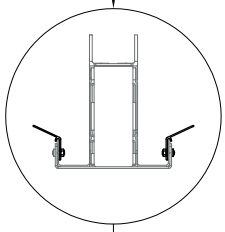
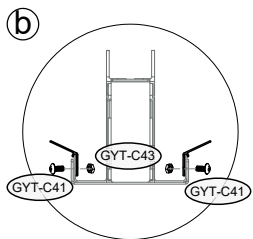
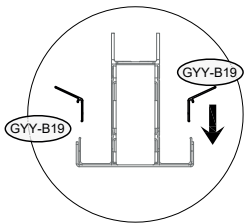
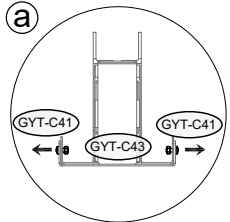
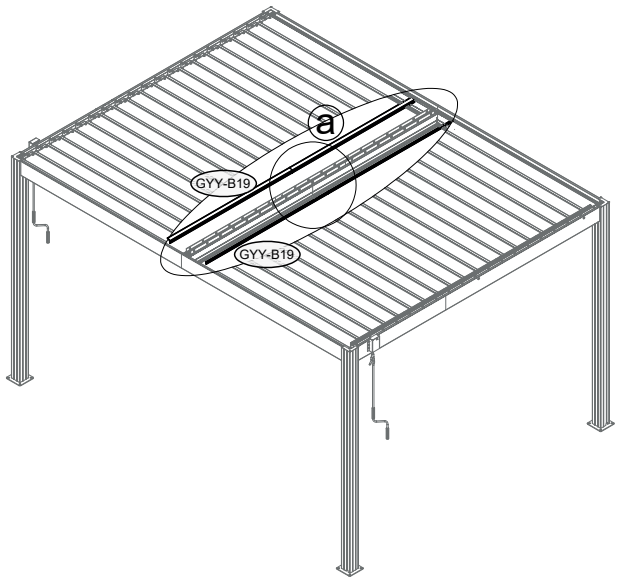





۲۷

